

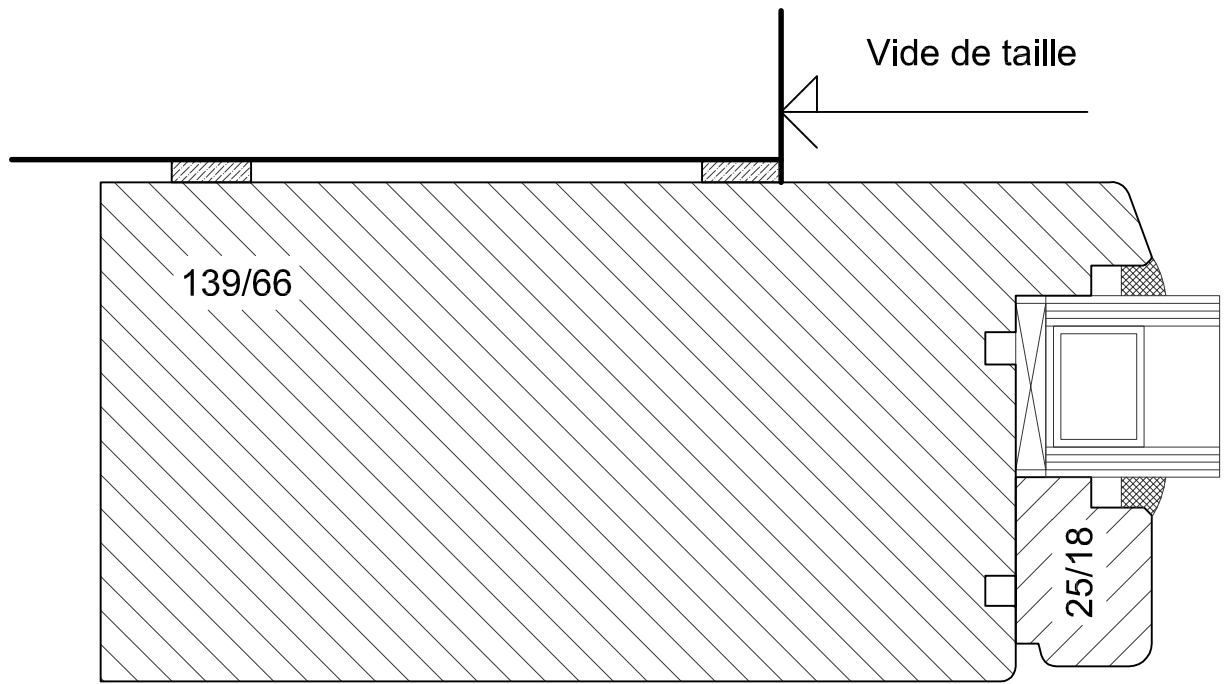

	Bois 66-78	Echelle 1 : 1
	Fixe dans le cadre	Date 14/02/2012
		B/66/100



	Bois 66-78	Echelle 1 : 1
	Baie-fixe	Date 14/02/2012
		B/66/101

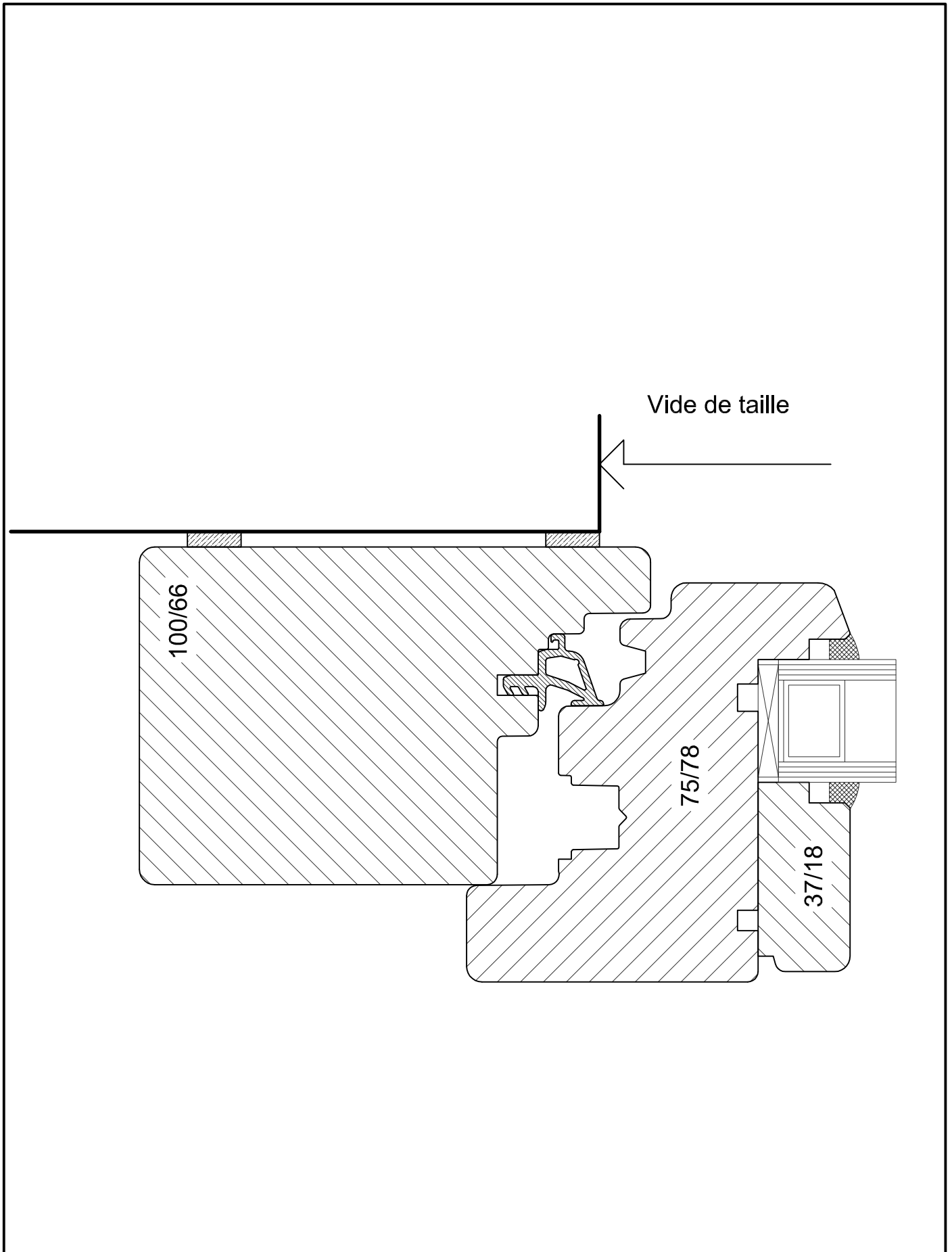

	Bois 66-78	Echelle 1 : 1
	Montant standard	Date 14/02/2012
		B/66/102

B/66/102a	14/02/2012	Echelle 1 : 1
-----------	------------	------------------

**Déjeze Fenêtres**

Bois 66-78.dwg  
Montants avec chassis croisillons

B/66/102a	14/02/2012	Echelle 1 : 1
-----------	------------	------------------

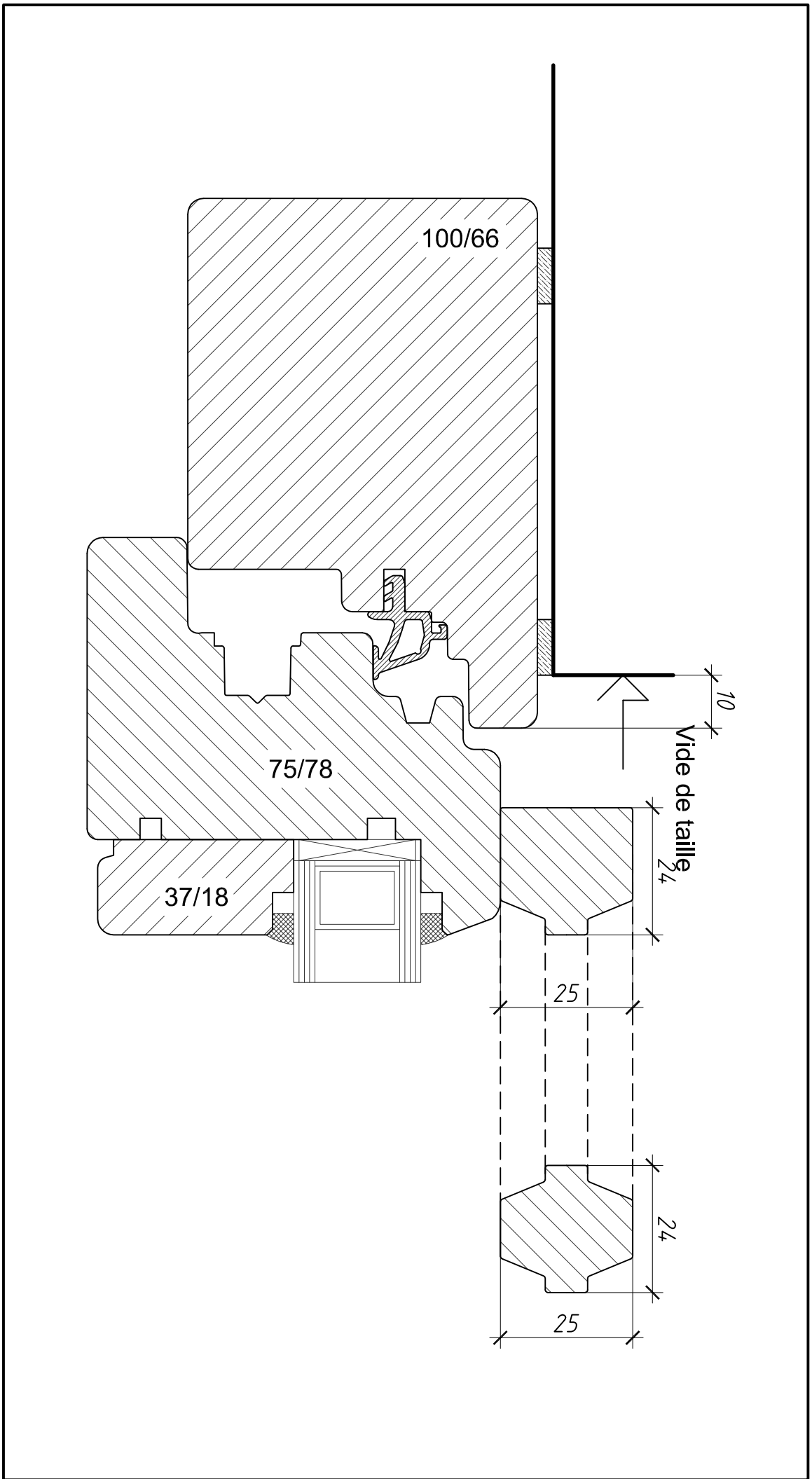

B/66/102c
Date 14/02/2012
Echelle 1 : 1

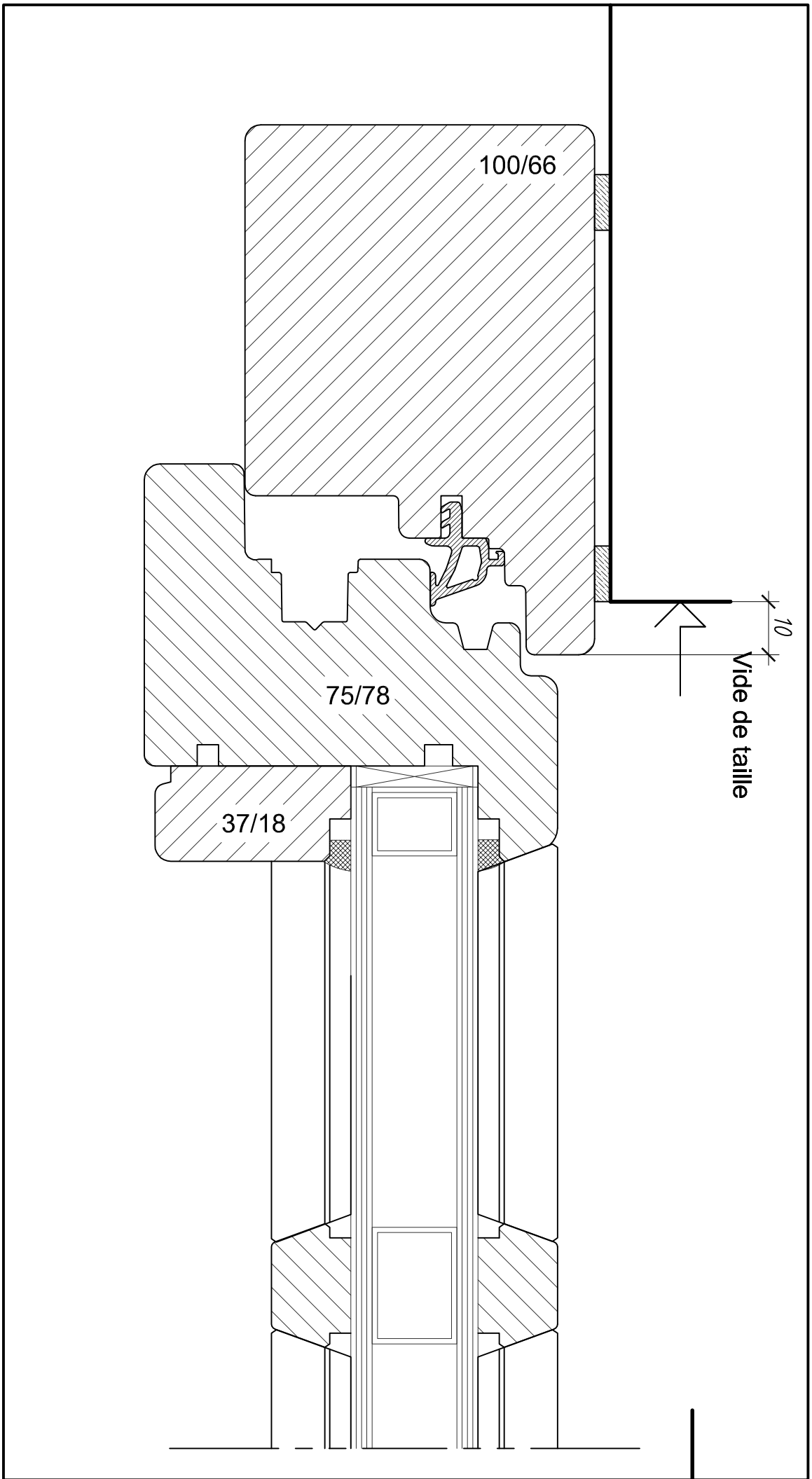

**Fenêtres**  
  
**Déjeze**

Bois 66-78.dwg  
 Croisillons rapporté intérieurs et extérieurs  
 sur vi double

Echelle 1 : 1
Date 14/02/2012
B/66/102c

B/66/102c1	14/02/2012	Echelle 1 : 1
------------	------------	------------------

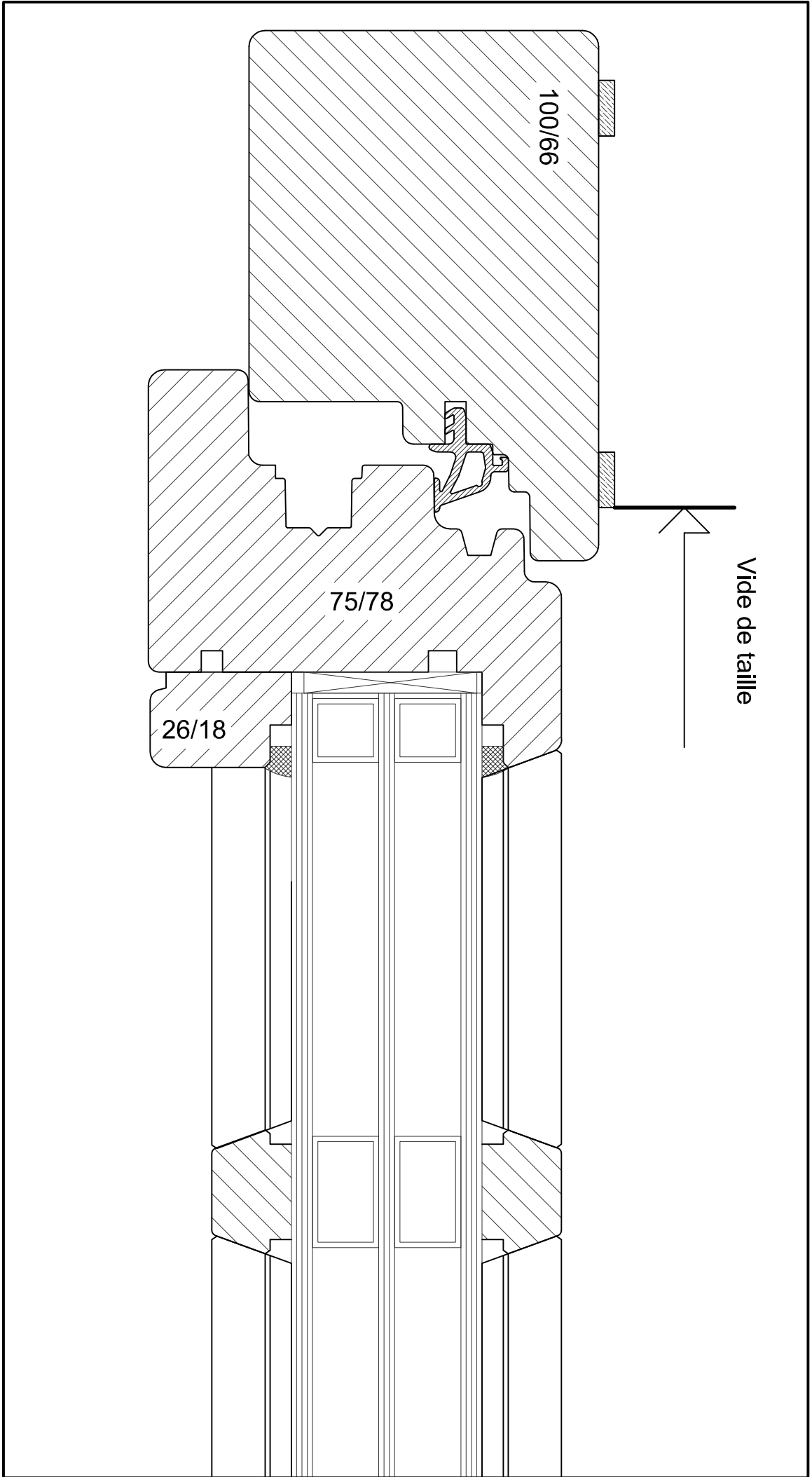

**Fenêtres**  
  
**Déléze**

Bois 66-78.dwg		Echelle 1 : 1
Croisillons rapporté intérieurs et extérieurs sur vi triple		Date 14/02/2012
		B/66/102c1

B/66/102d
Date 17/02/2012
Echelle 1 : 1

**Déjeze** Fenêtres

Bois 2012 client.dwg  
Montants ou traverse intermédiaire guichet

Echelle 1 : 1
Date 17/02/2012
B/66/102d

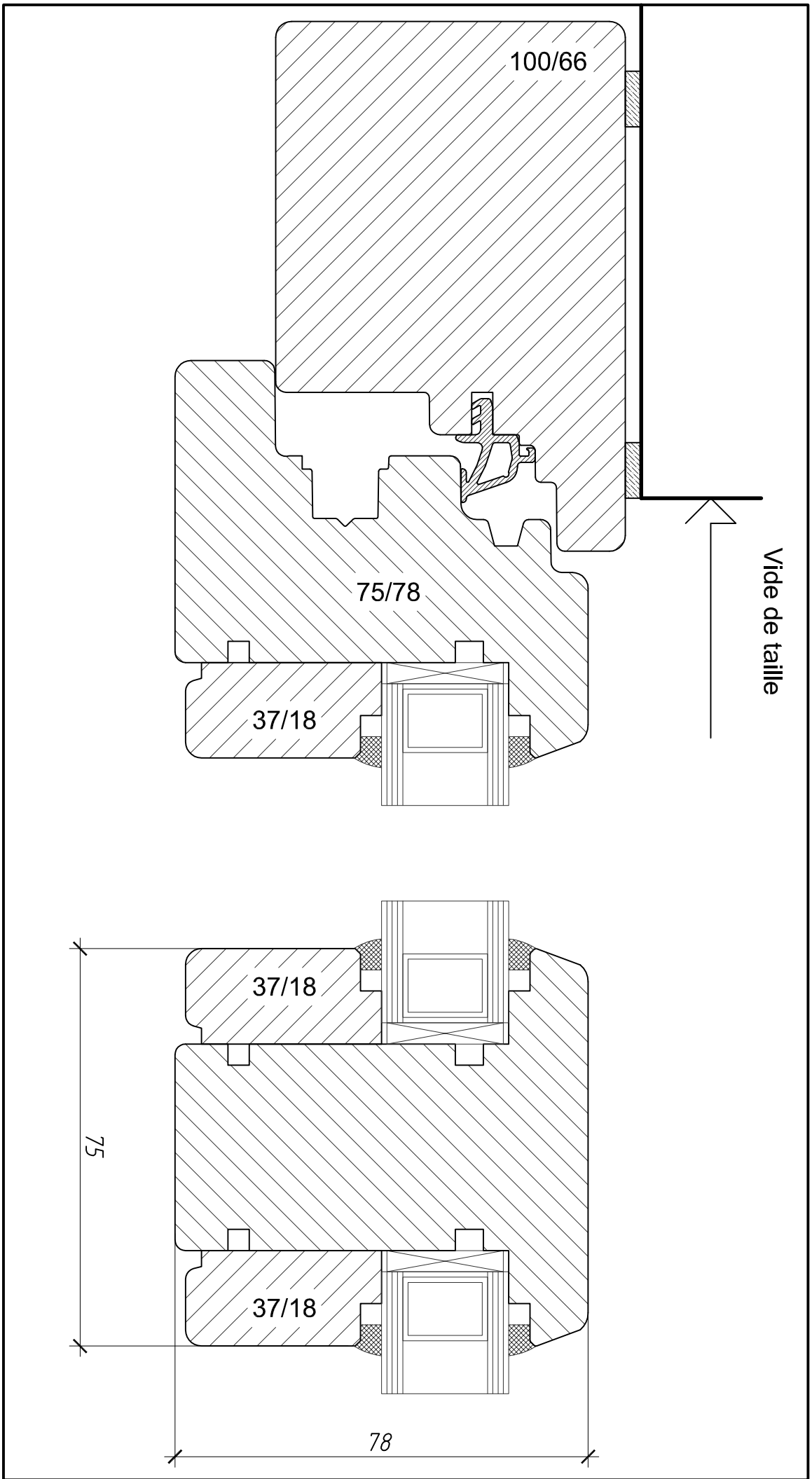

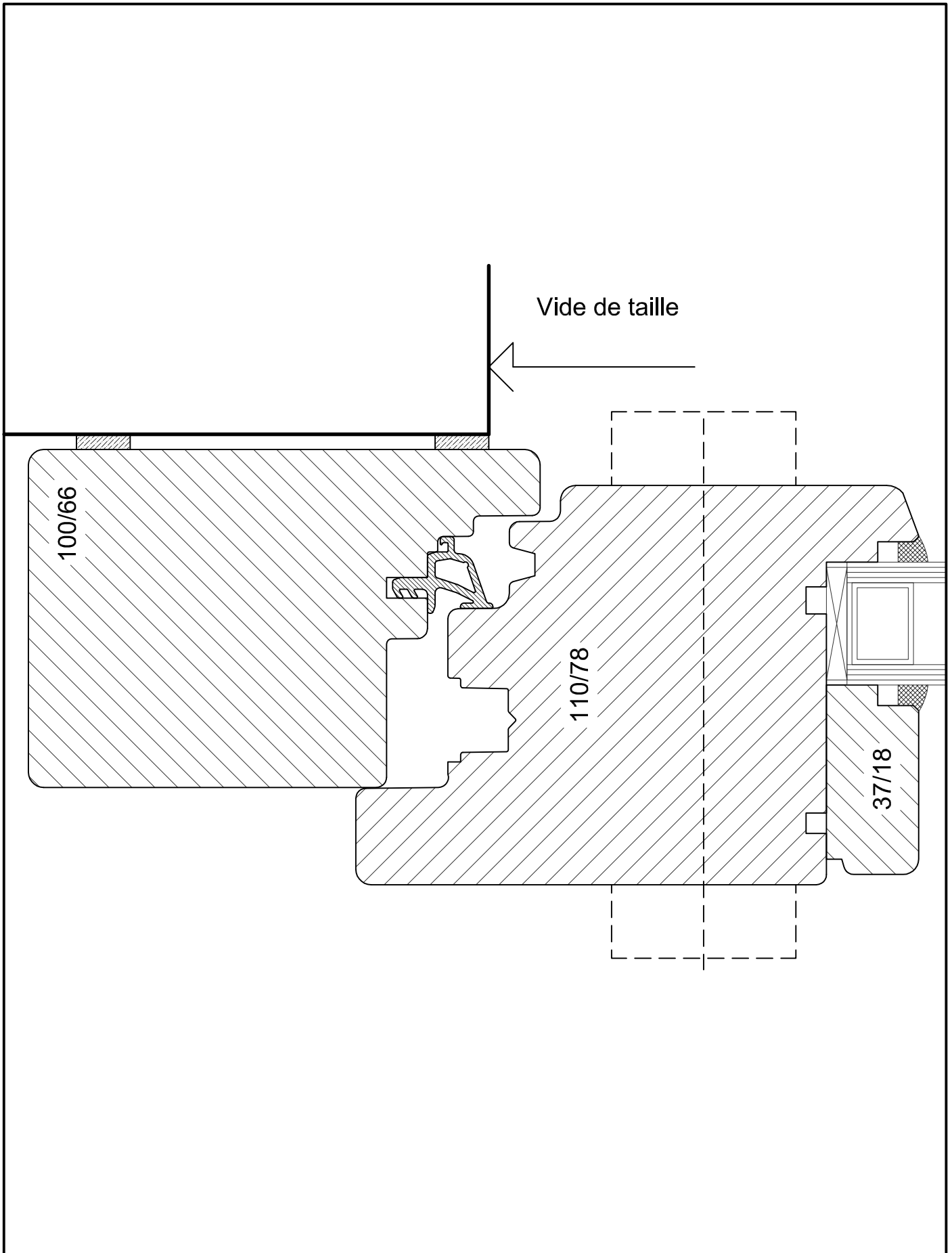

	Bois 2012 client	Echelle 1 : 1
	Montants Balcover poignée traversante	Date 17/02/2012
		B/66/103



B/66/104	17/02/2012	Echelle 1 : 1
----------	------------	------------------

**Déjeze** Fenêtres

Bois 2012 client.dwg  
Montants Porte entrée poignée traversante

B/66/104	17/02/2012	Echelle 1 : 1
----------	------------	------------------

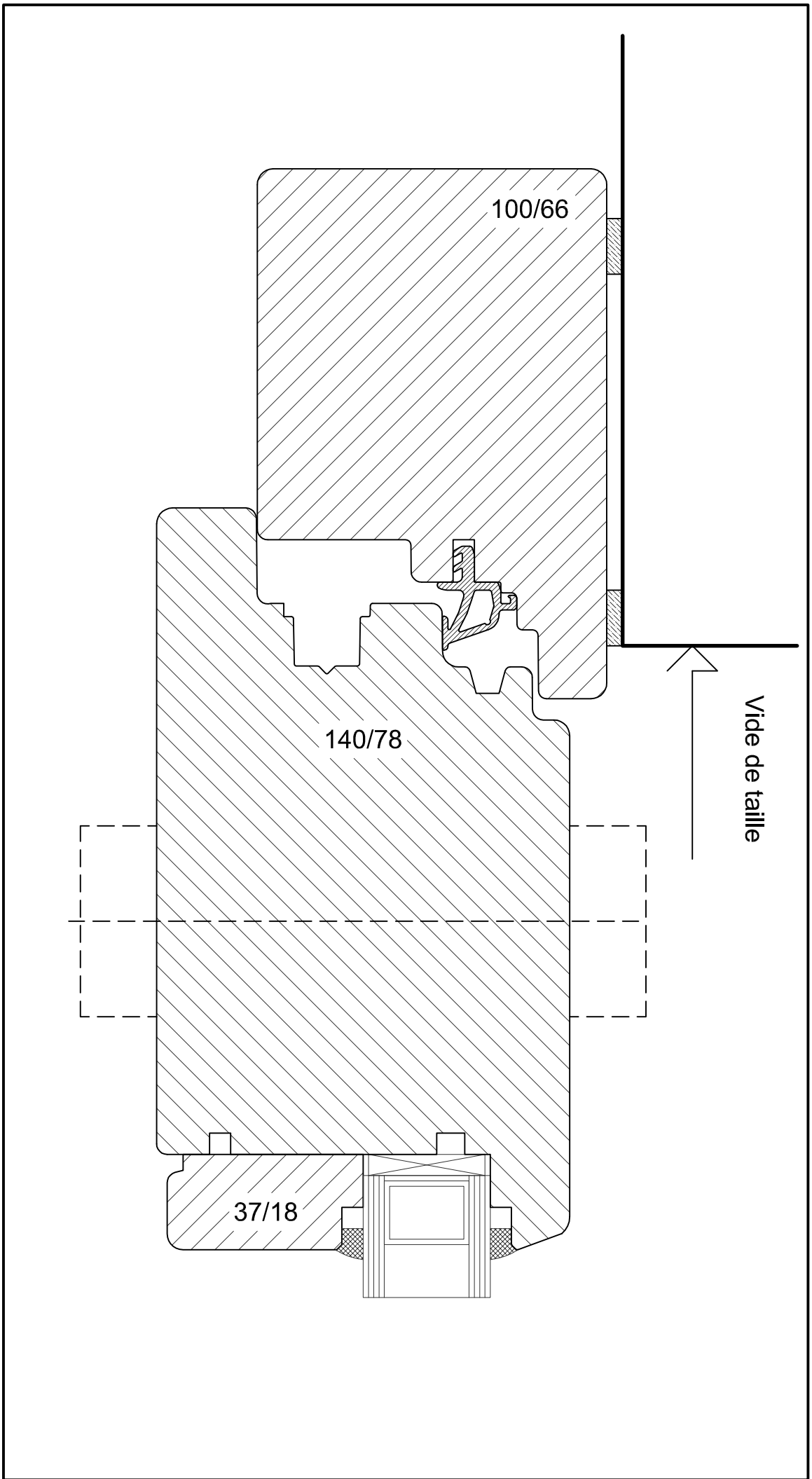

B/66/105	17/02/2012	Echelle 1 : 1
----------	------------	------------------

**Déjeze** Fenêtres

Bois 2012 client.dwg  
 Montants Porte ouverture sur l'extérieur

B/66/105	17/02/2012	Echelle 1 : 1
----------	------------	------------------

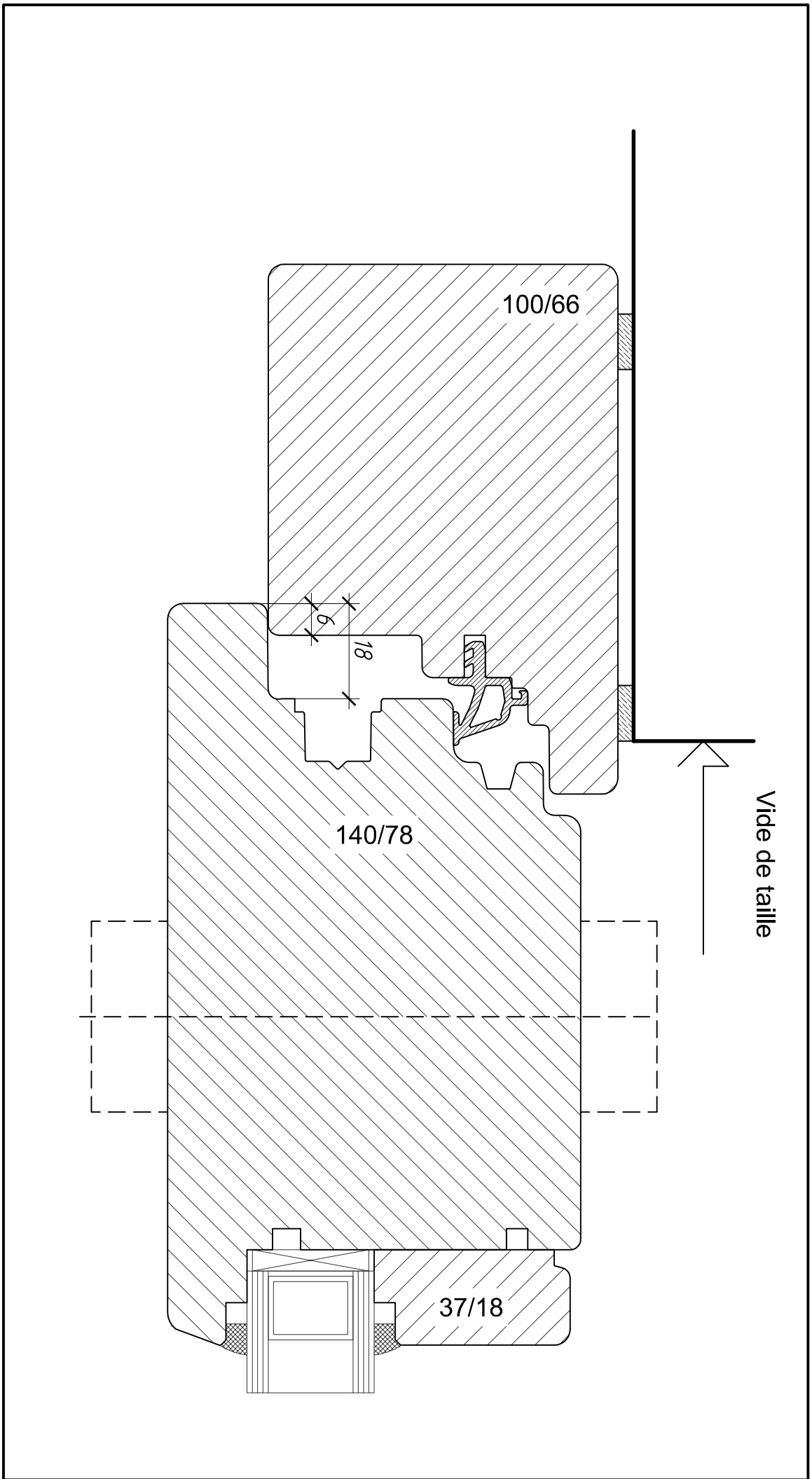

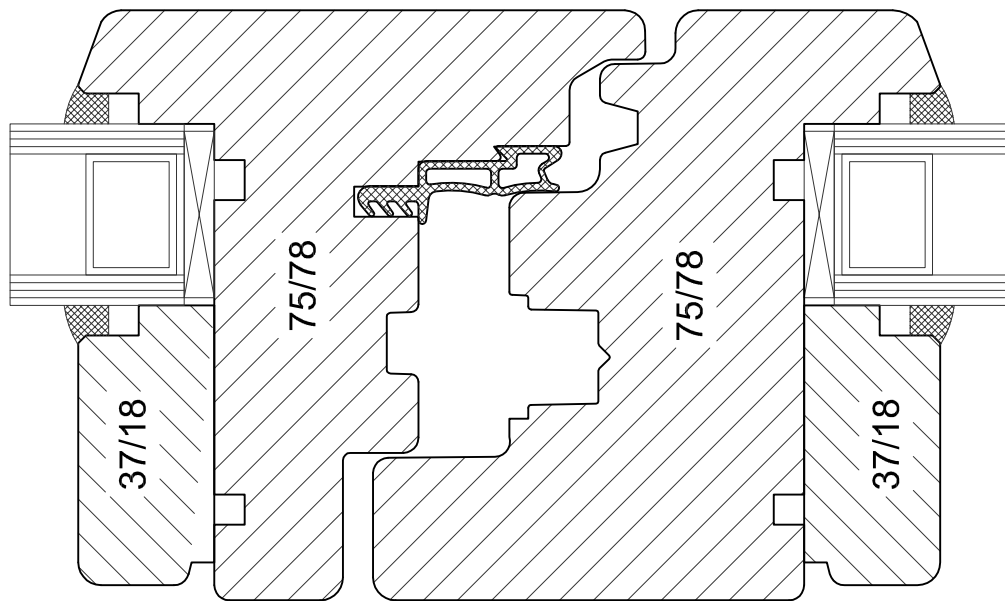

	Bois 2012 client	Echelle 1 : 1
	Montants central	Date 17/02/2012
		B/66/200

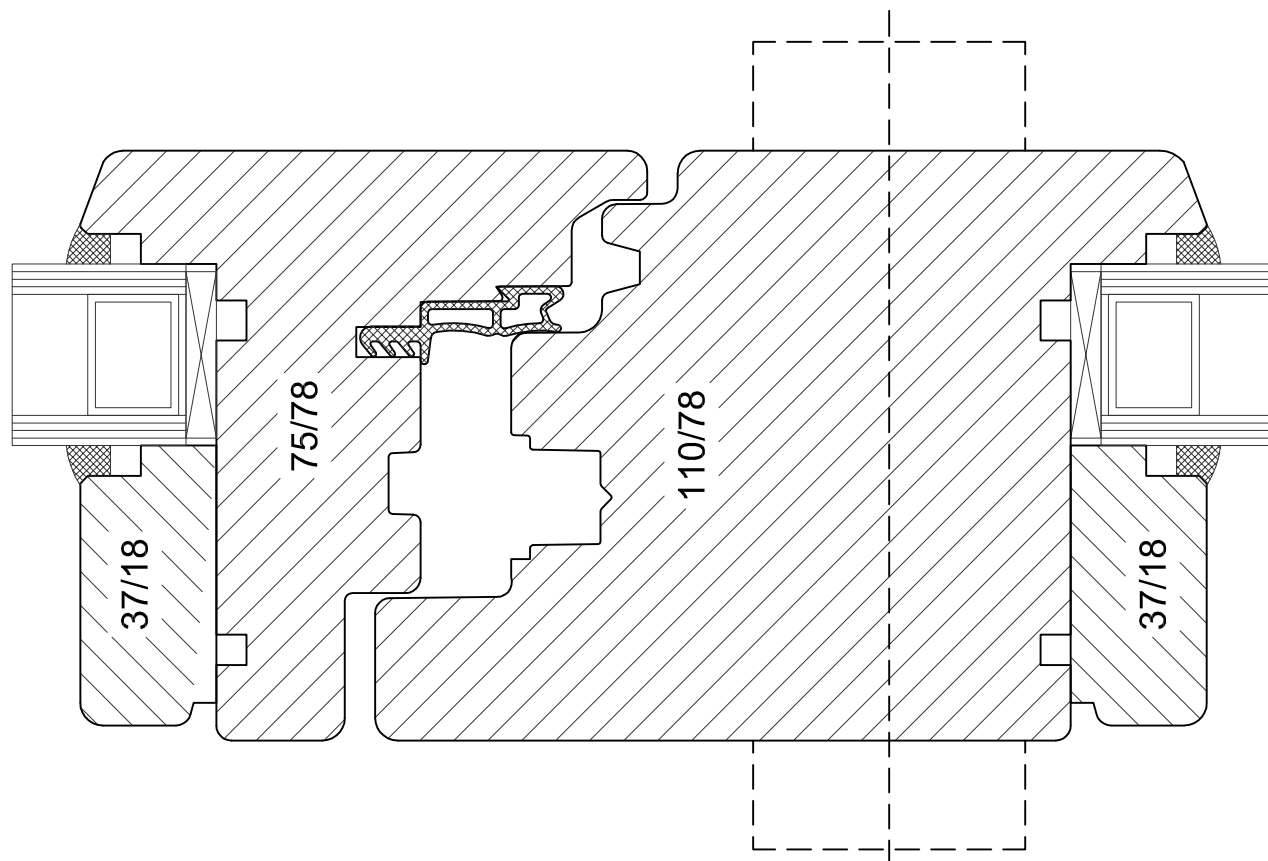

	Bois 2012 client	Echelle 1 : 1
	Montants central balcover	Date 17/02/2012
		B/66/201

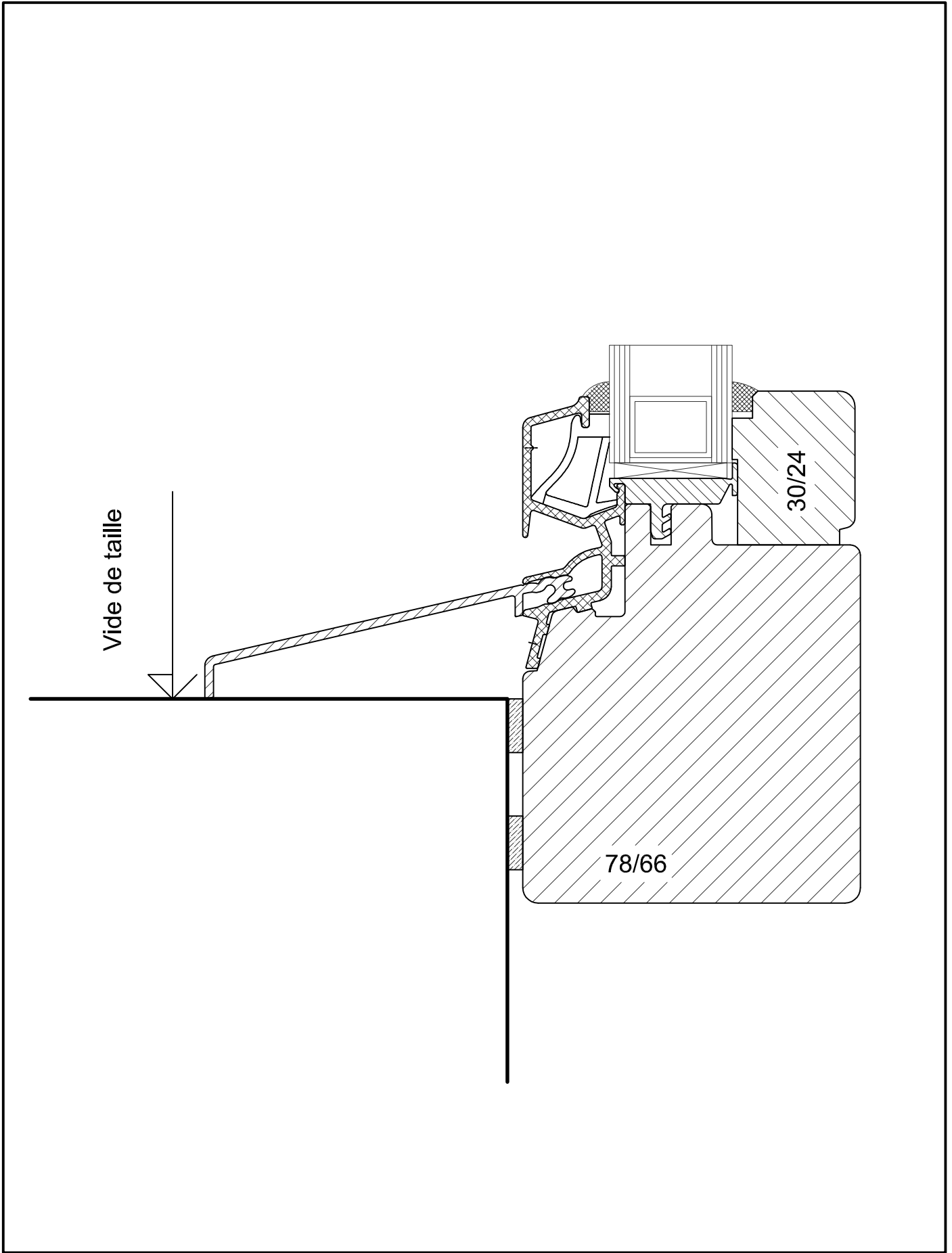

	Bois 2012 client	Echelle 1 : 1
	Fixe dans le cadre	Date 17/02/2012
		B/66/300

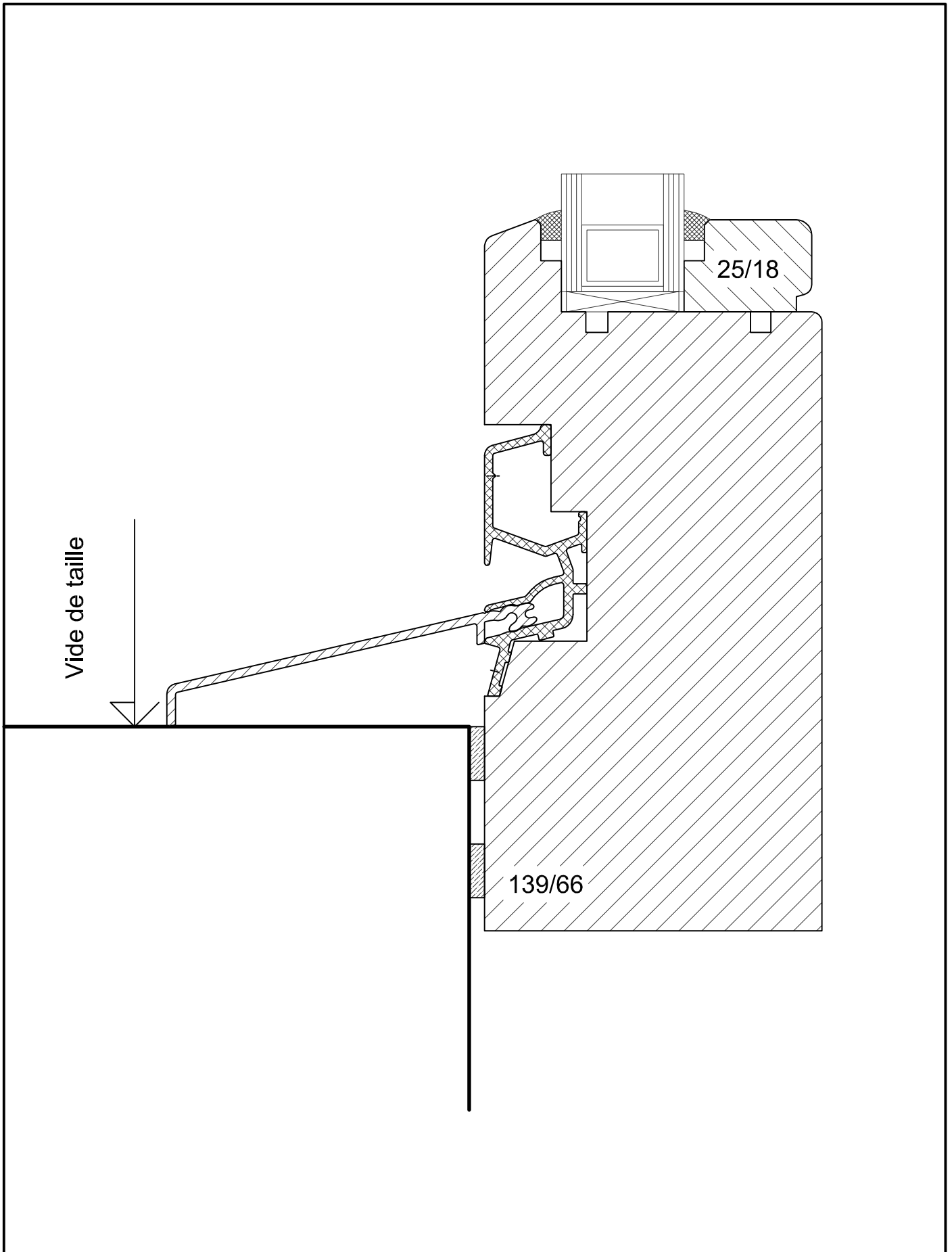

	Bois 2012 client	Echelle 1 : 1
	Baie-fixe	Date 17/02/2012
		B/66/301

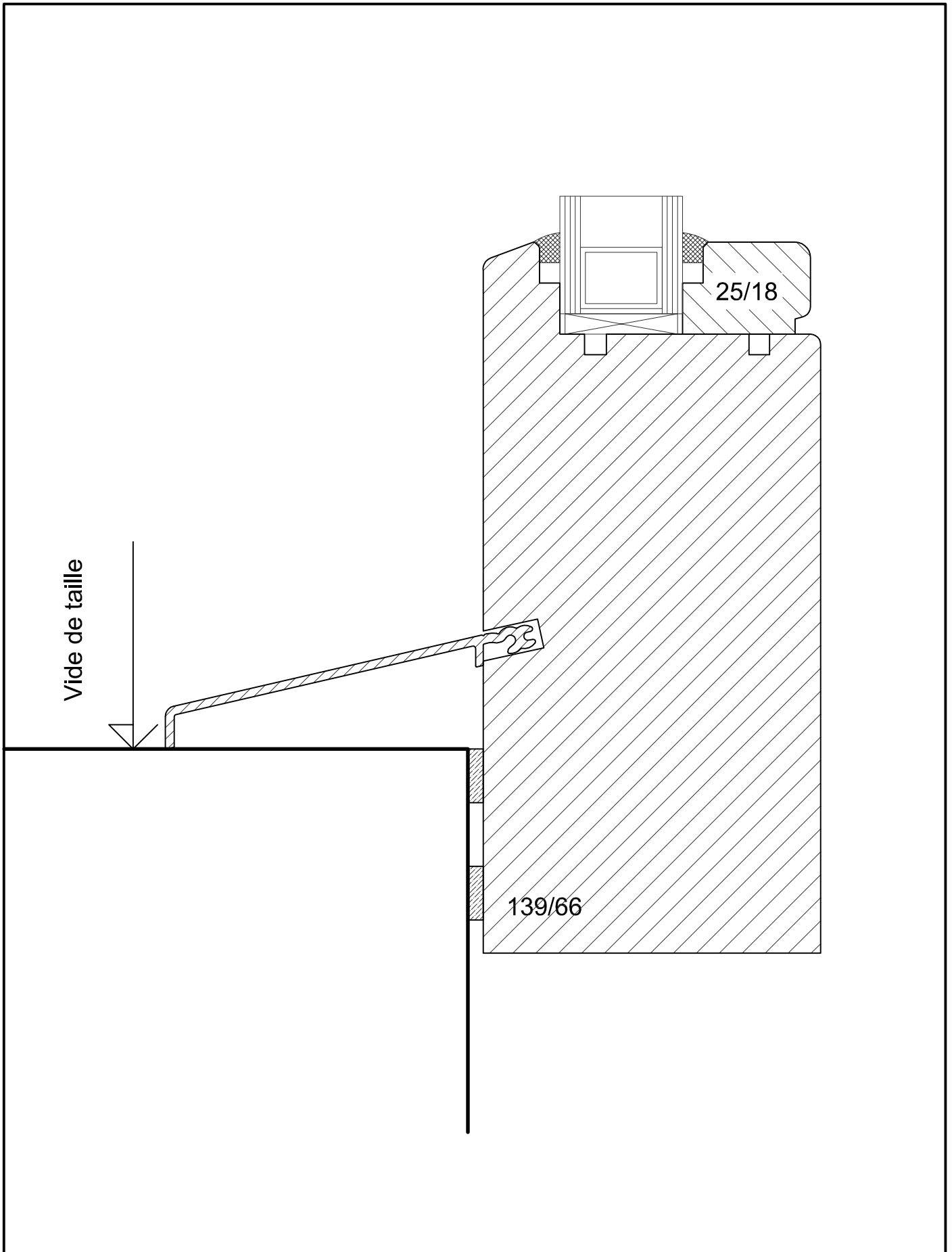

	Bois 2012 client	Echelle 1 : 1
	Baie-fixe	Date 17/02/2012
		B/66/301A

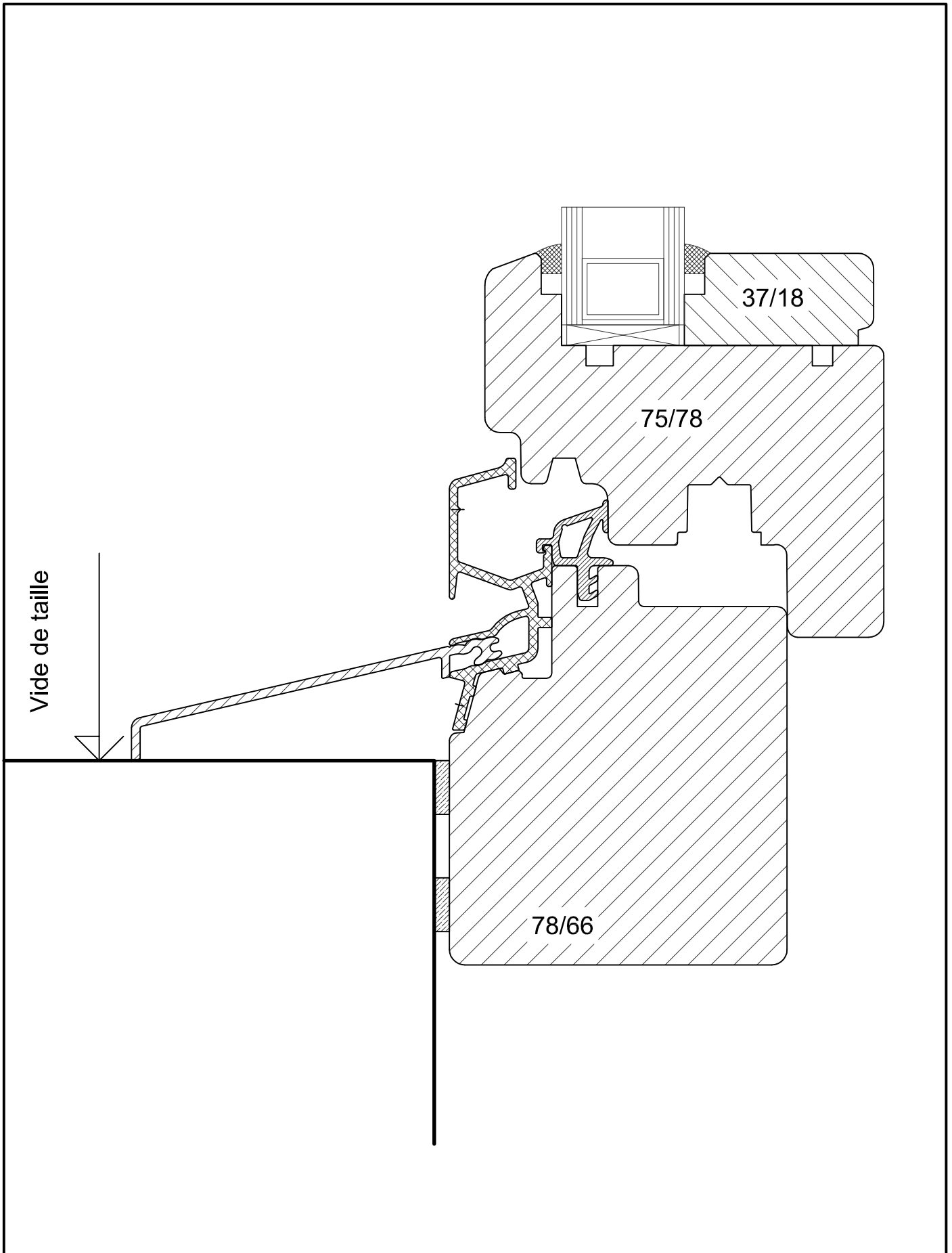

	Bois 2012 client	Echelle 1 : 1
	Traverse basse standard	Date 17/02/2012
		B/66/302



B/66/303	17/02/2012	Echelle 1 : 1
----------	------------	------------------

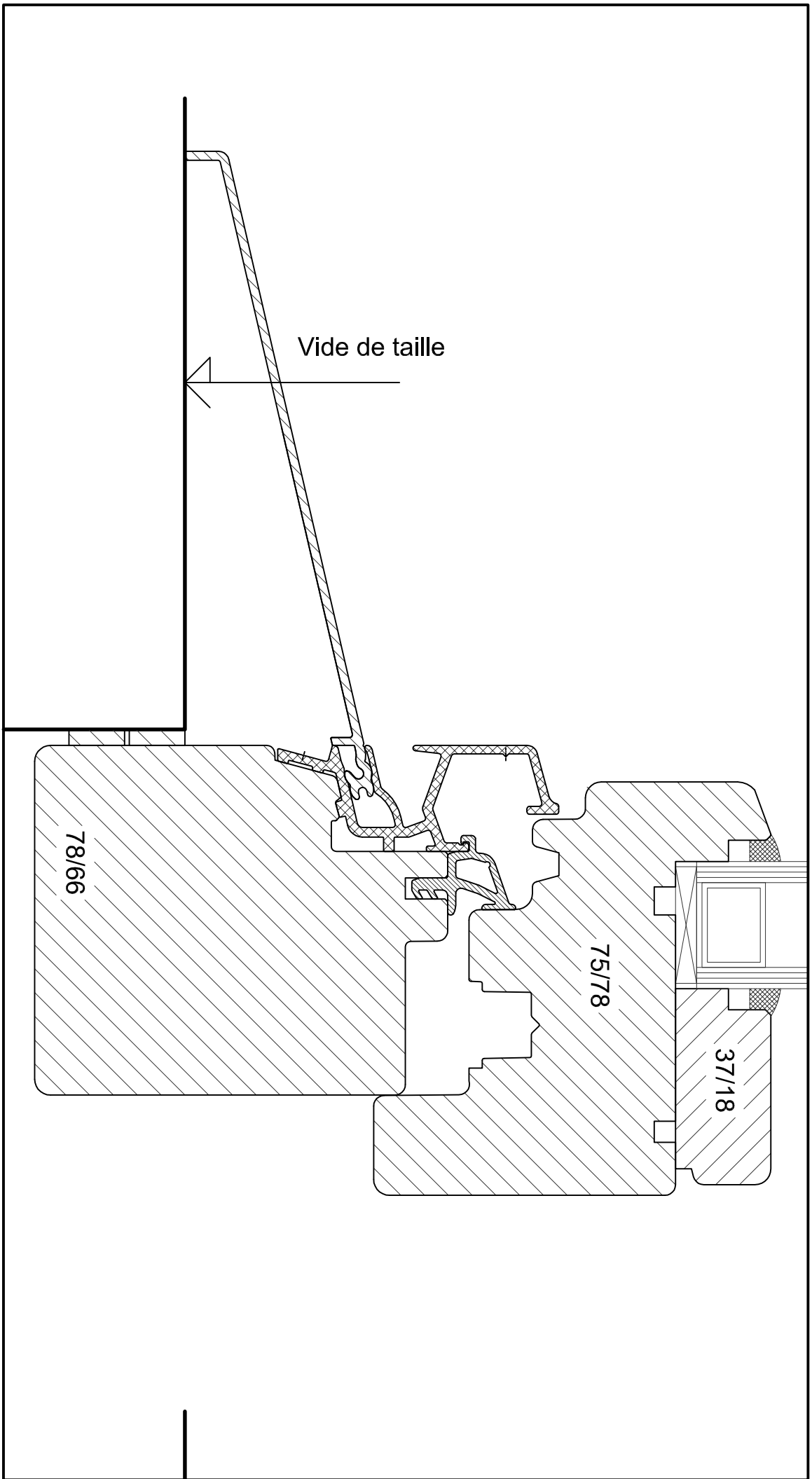

**Déjeze Fenêtres**

Bois 2012 client.dwg  
 Traverse basse rvd'eau 115mm

Echelle 1 : 1	Date 17/02/2012
------------------	--------------------

B/66/303

B/66/304	17/02/2012	Echelle 1 : 1
----------	------------	------------------

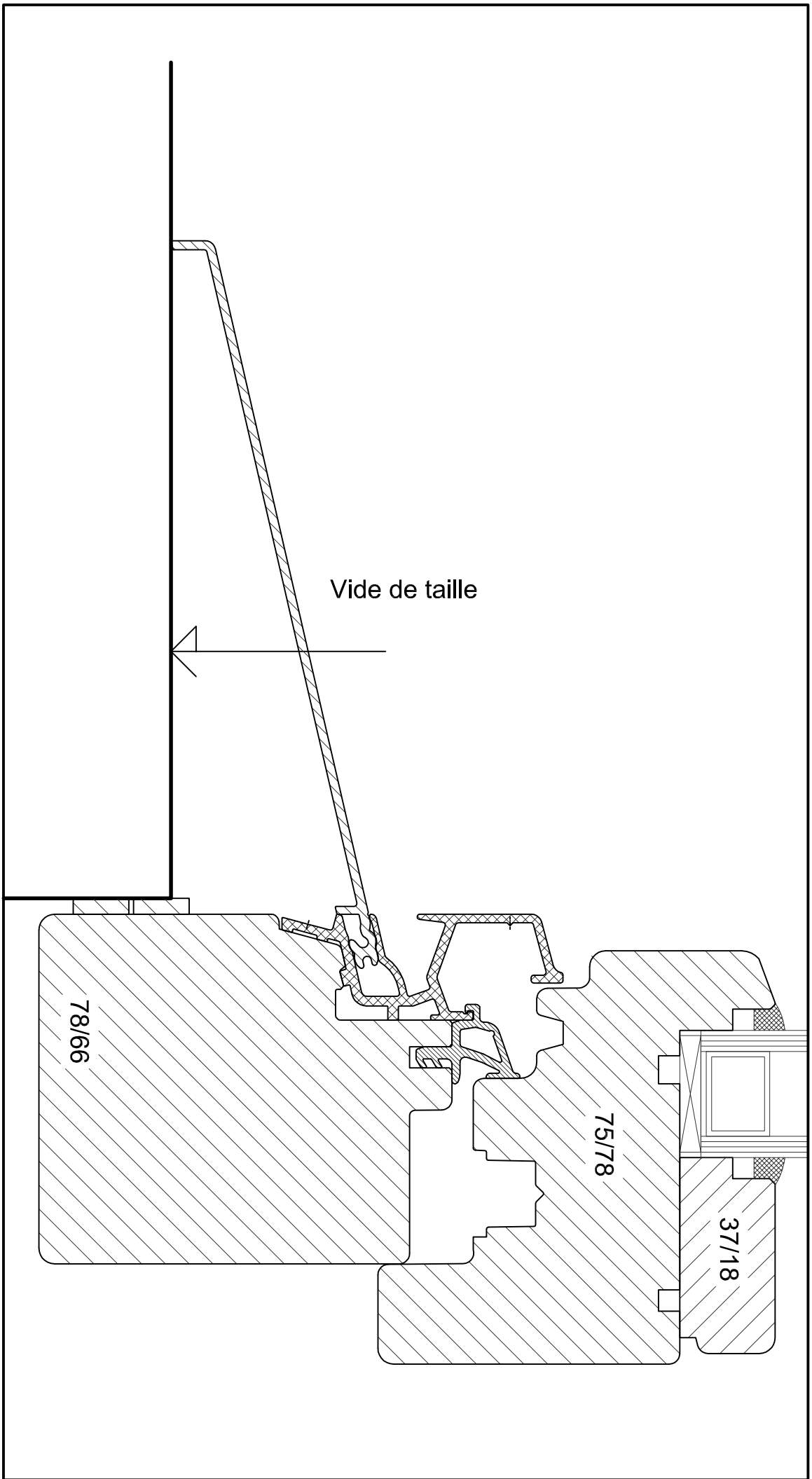

**Déjeze** Fenêtres

Bois 2012 client.dwg  
 Traverse basse rvd'eau 130mm

B/66/304	17/02/2012	Echelle 1 : 1
----------	------------	------------------

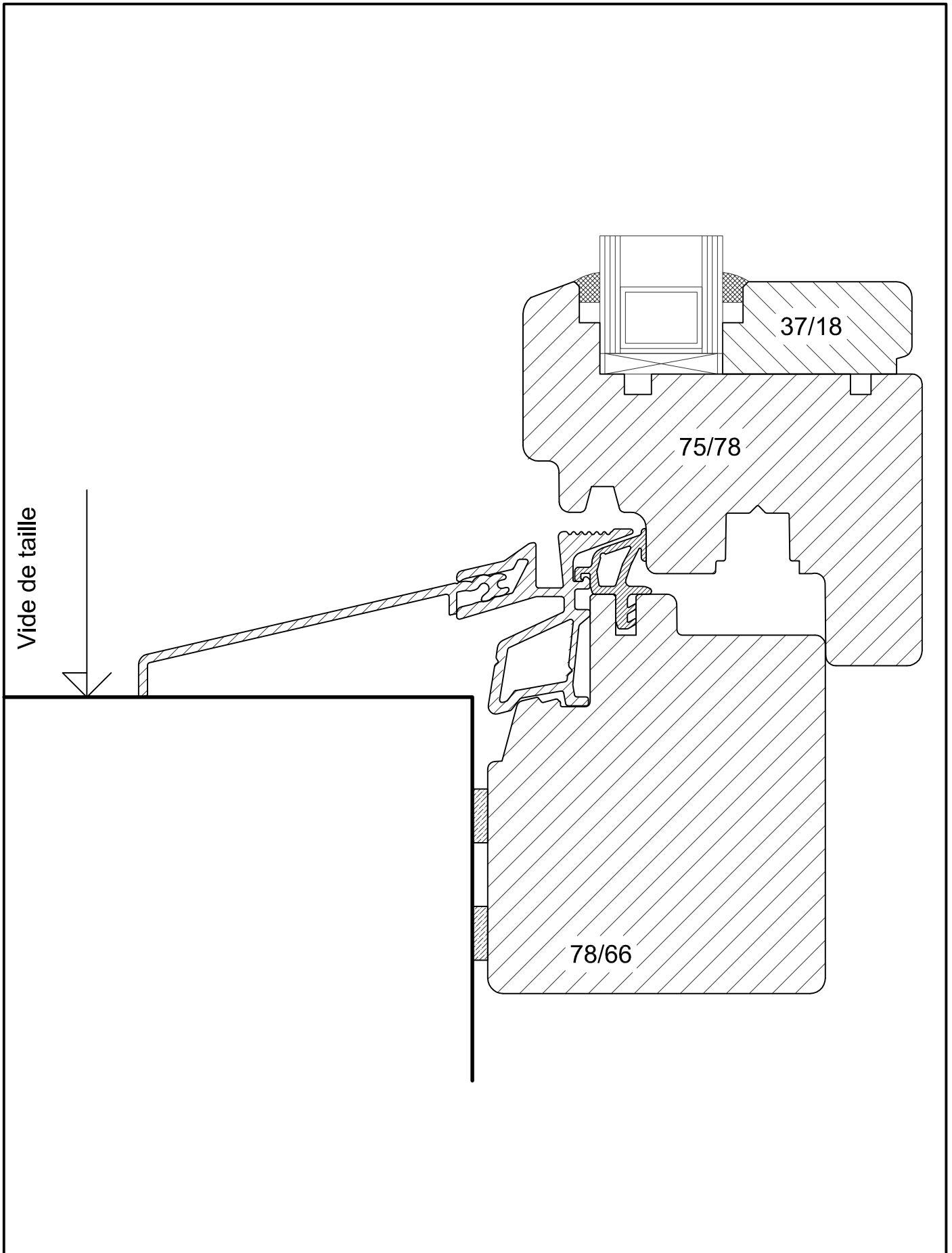

	Bois 2012 client	Echelle 1 : 1
	Traverse basse seuil minimum	Date 17/02/2012
		B/66/305

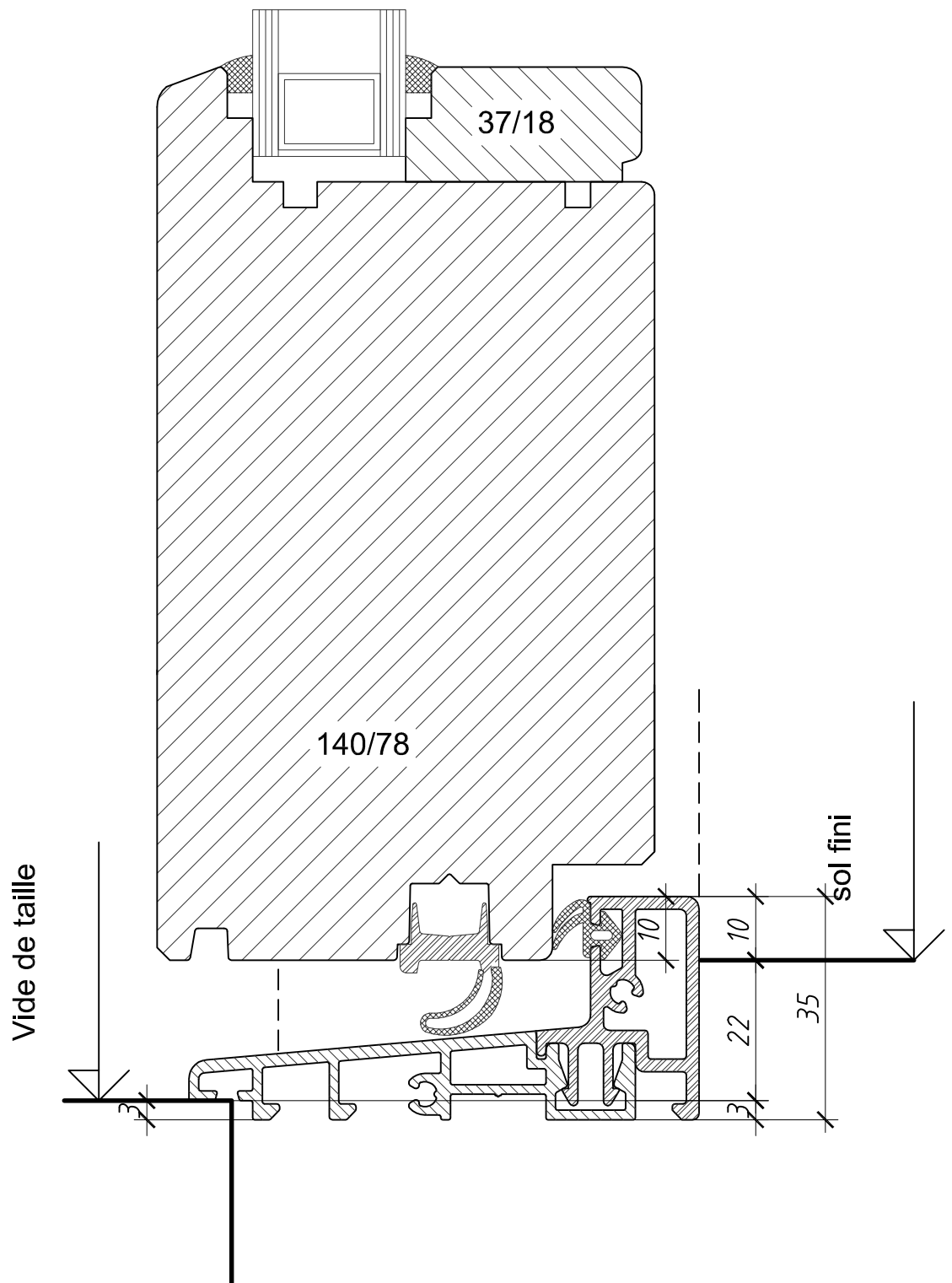

B/66/307

Date  
17/02/2012

Echelle  
1 : 1



Bois 2012 client.dwg  
Traverse basse Psk-2007 plus

Echelle  
1 : 1

Date  
17/02/2012

B/66/307

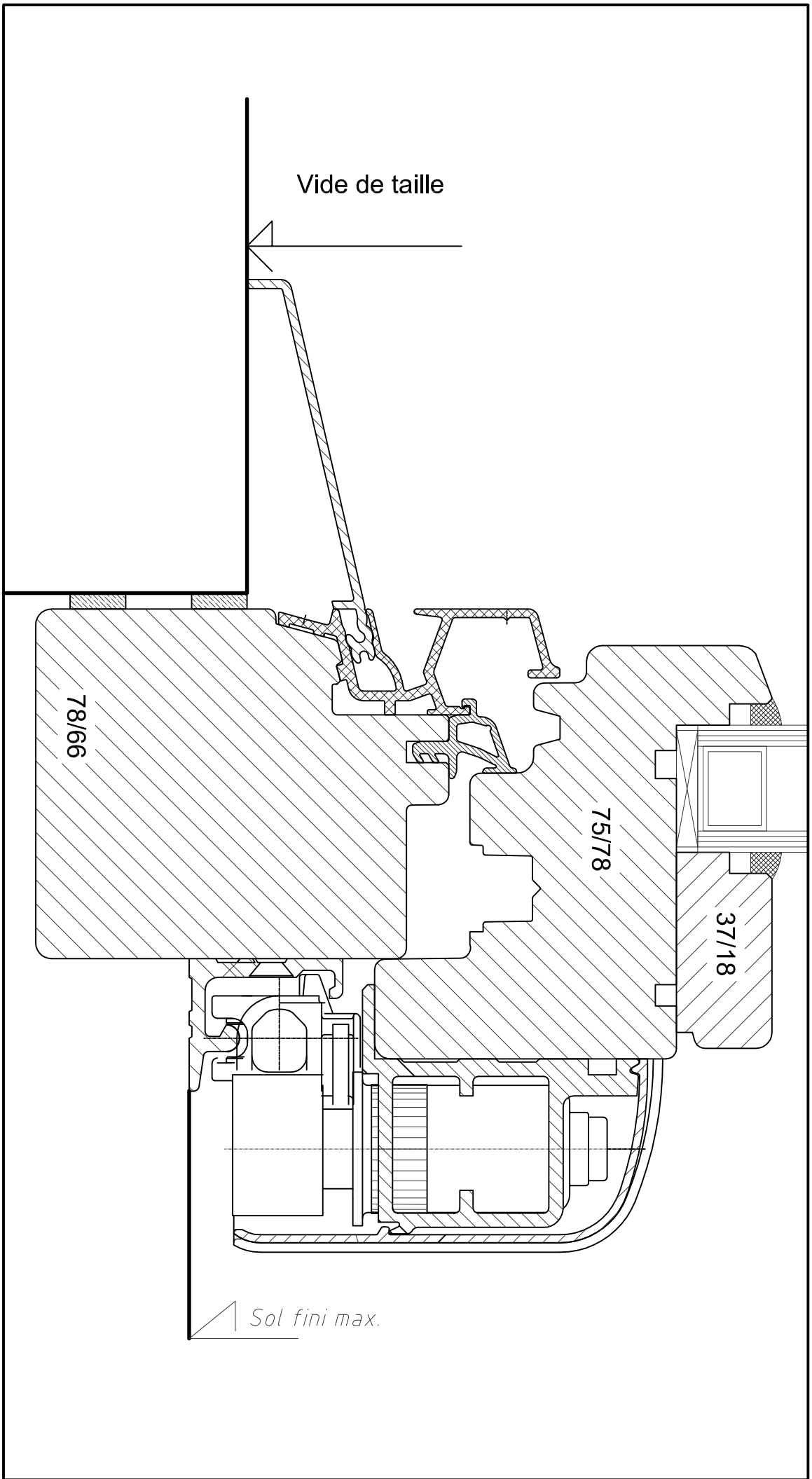

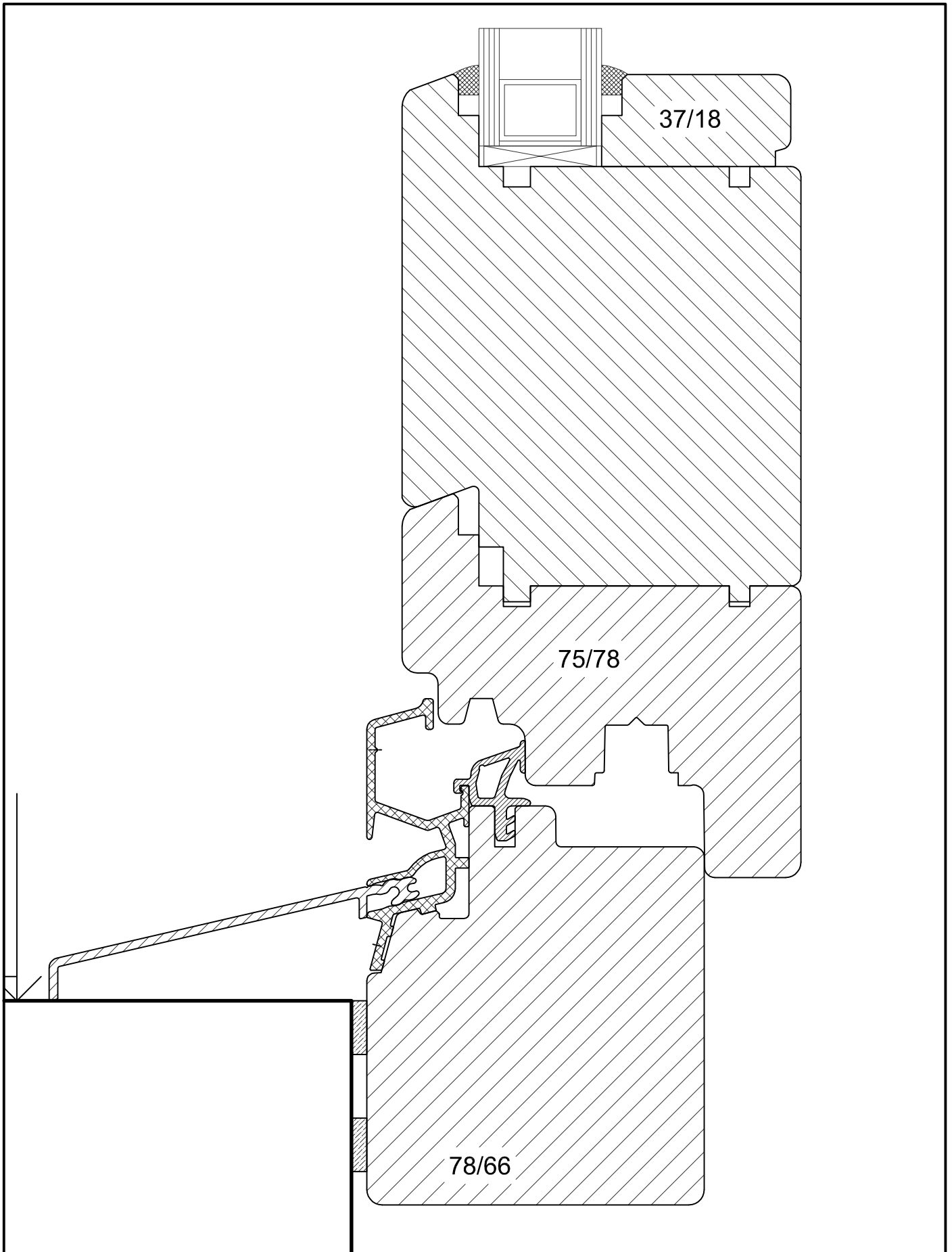

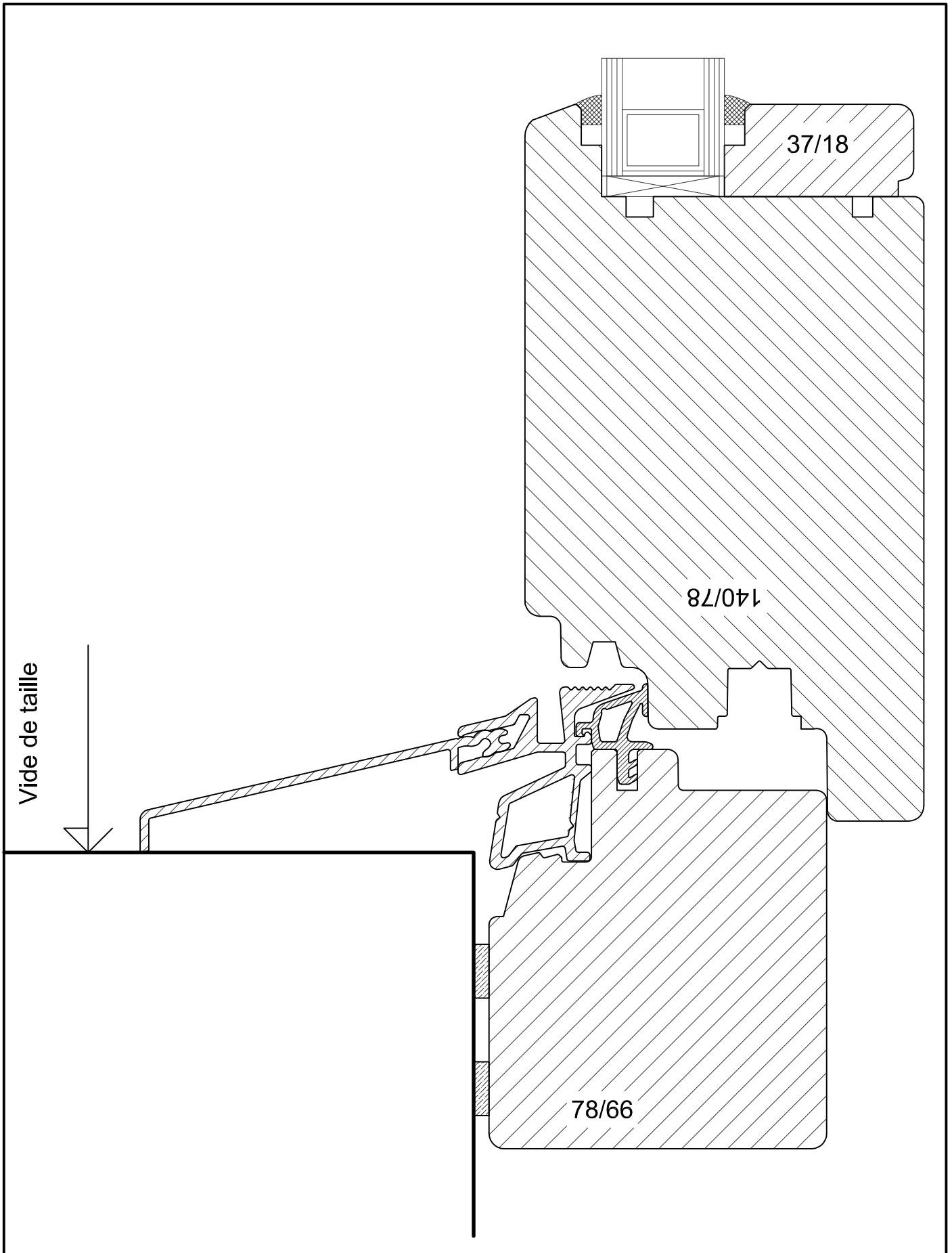

	Bois 2012 client	Echelle 1 : 1
	Traverse basse porte balcon avec remplissage	Date 17/02/2012
		B/66/308



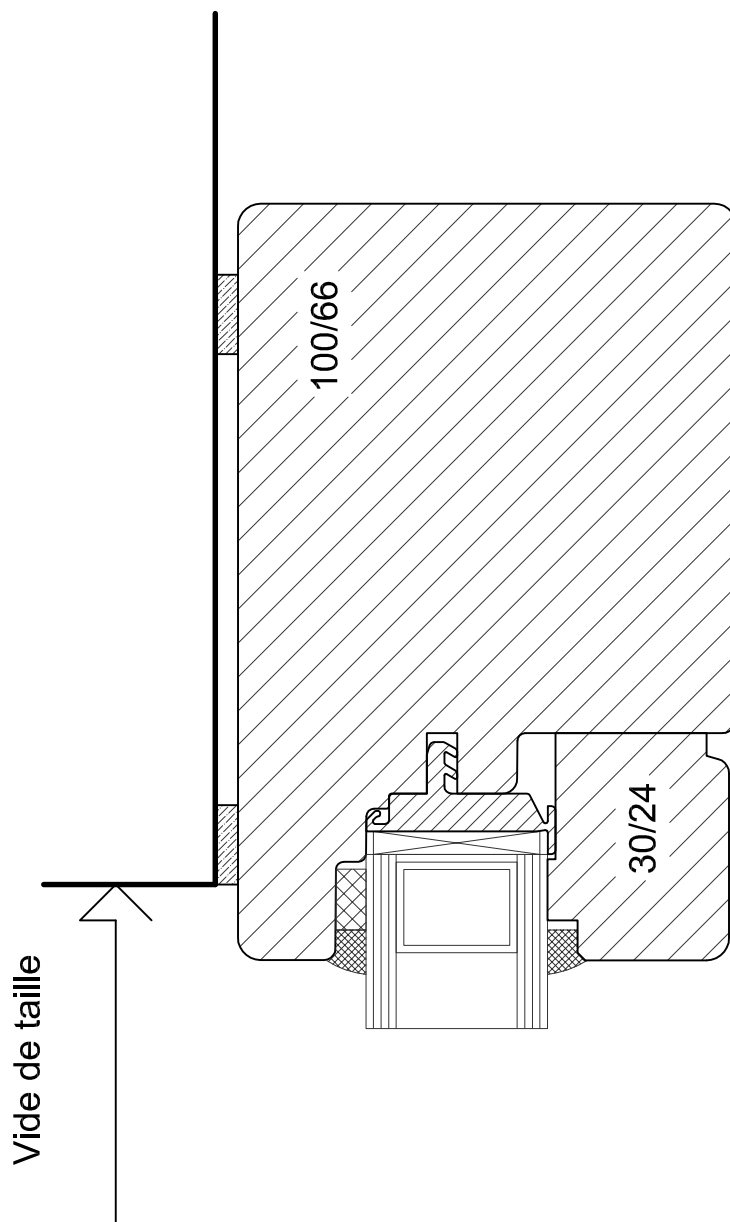

	Bois 2012 client	Echelle 1 : 1
	Traverse basse porte Entrée seuil min	Date 17/02/2012
		B/66/309



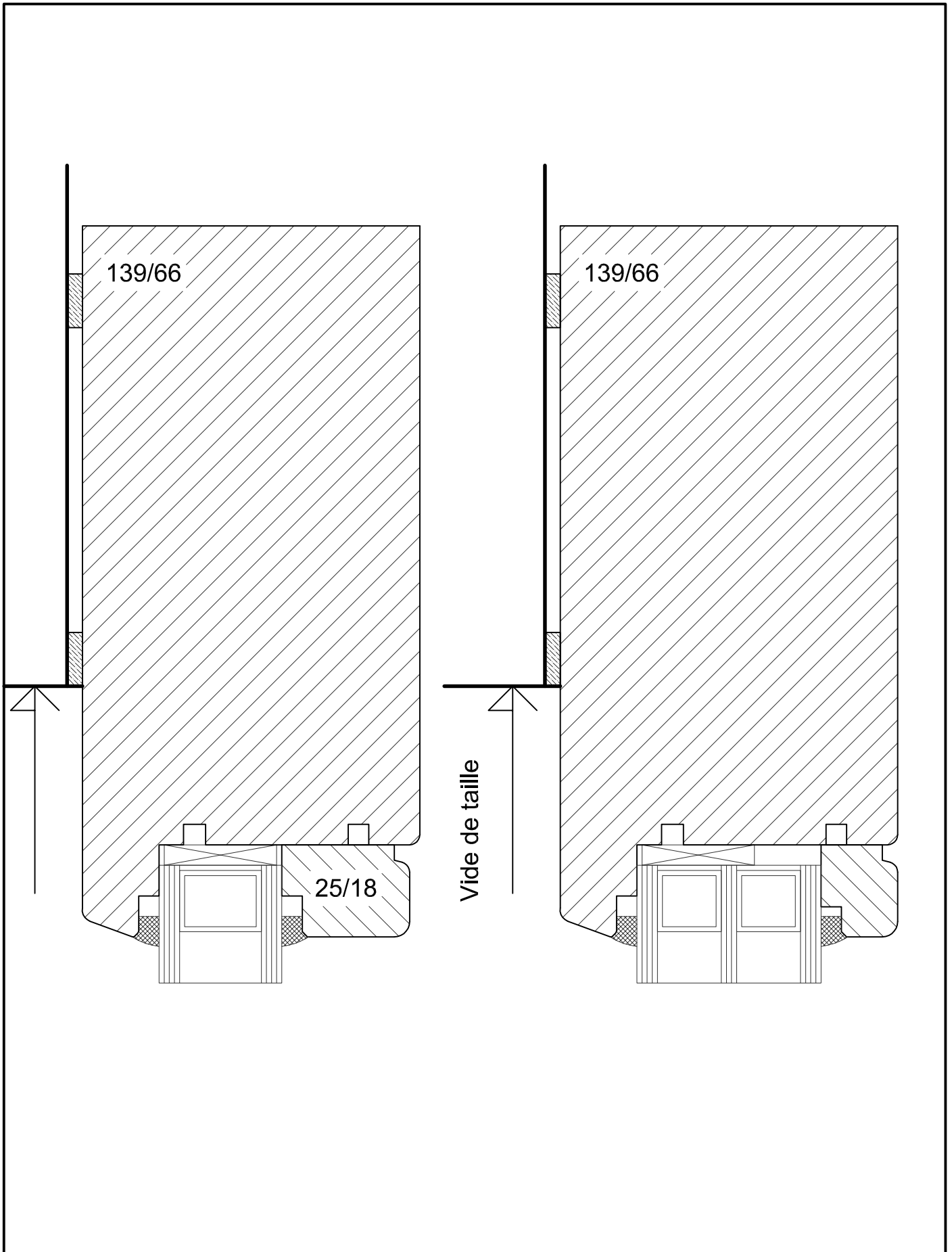

	Bois 2012 client	Echelle 1 : 1
	Traverse haute fixe dans le cadre	Date 17/02/2012
		B/66/400





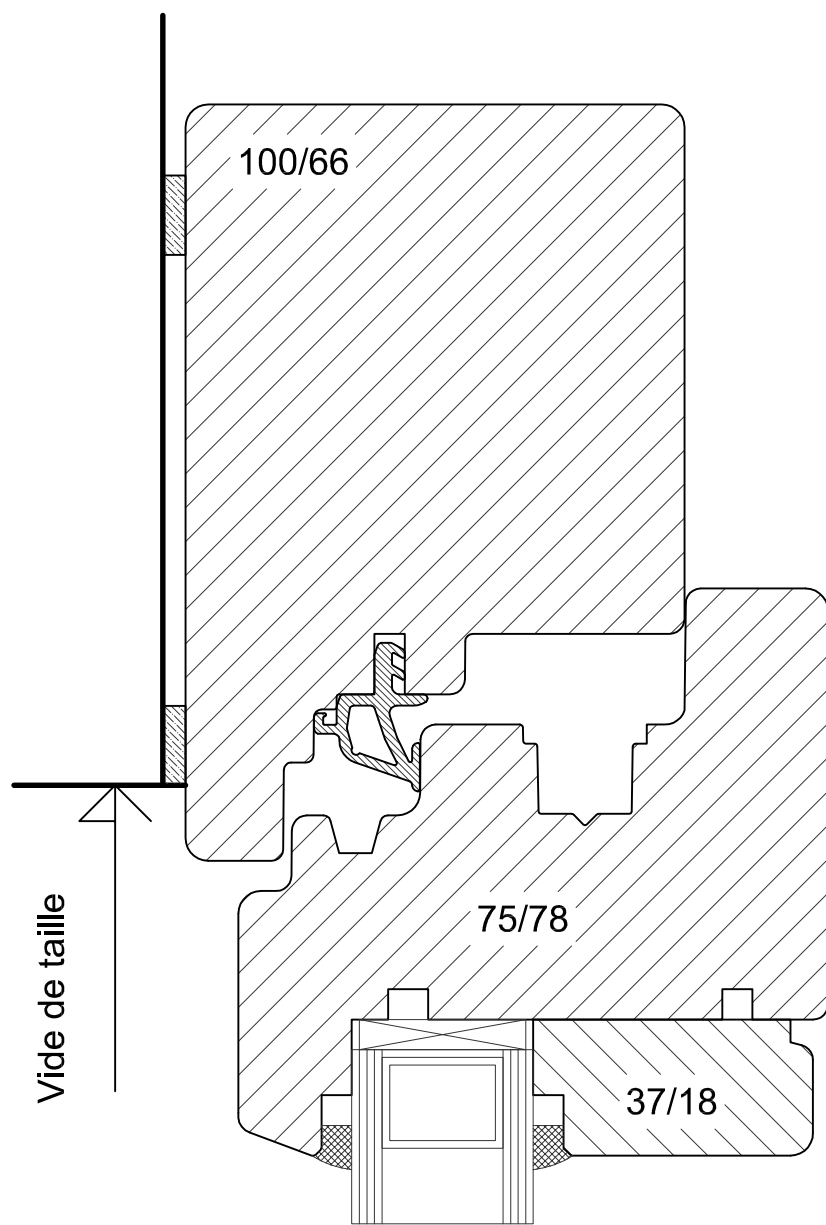

	Bois 2012 client	Echelle 1 : 1
	Traverse haute baie-fixe	Date 17/02/2012
		B/66/401

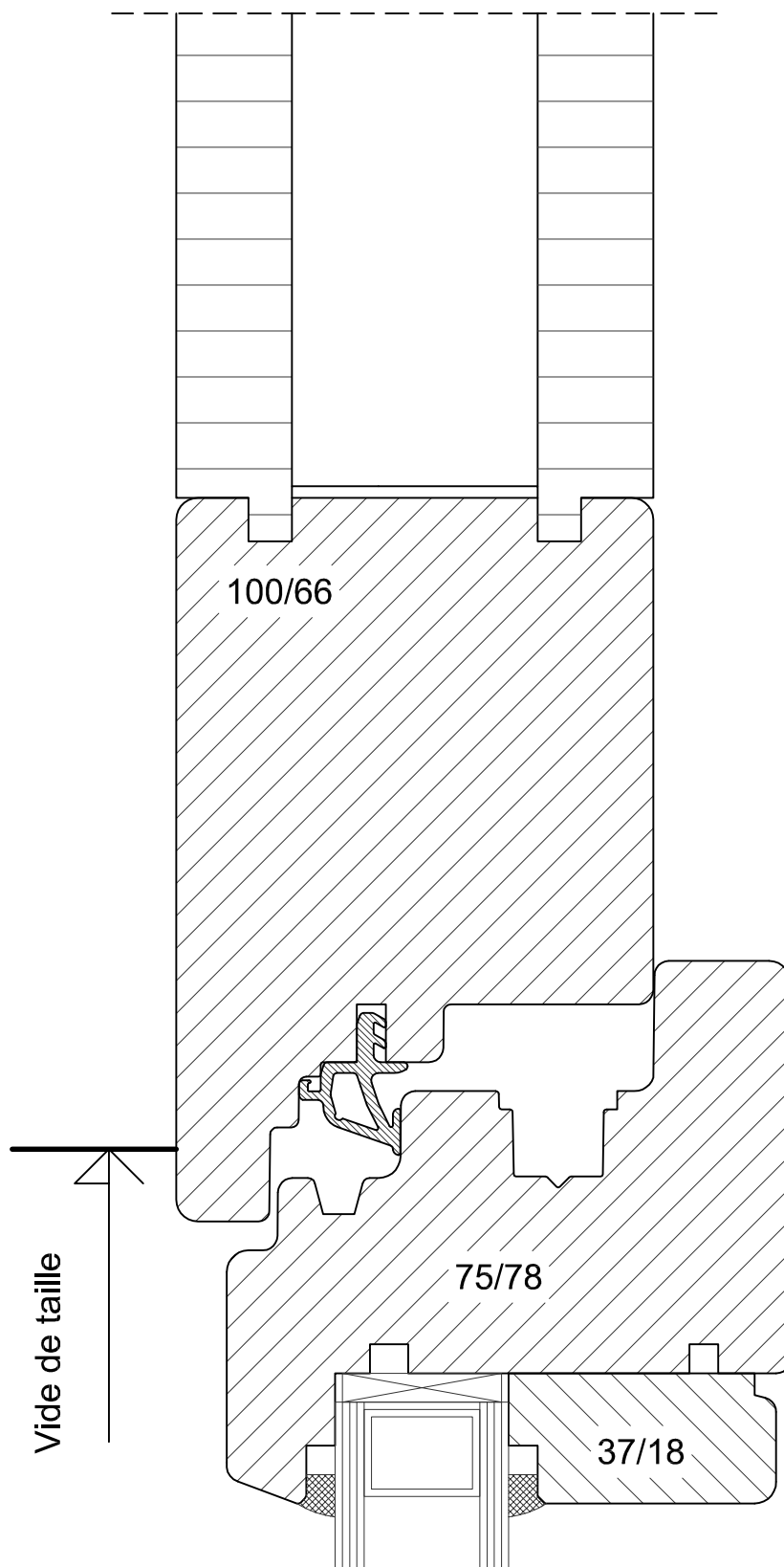

	Bois 2012 client	Echelle 1 : 1
	Traverse haute standard	Date 17/02/2012
		B/66/402



	Bois 2012 client	Echelle 1 : 1
	Traverse haute standard attique	Date 17/02/2012
		B/66/403

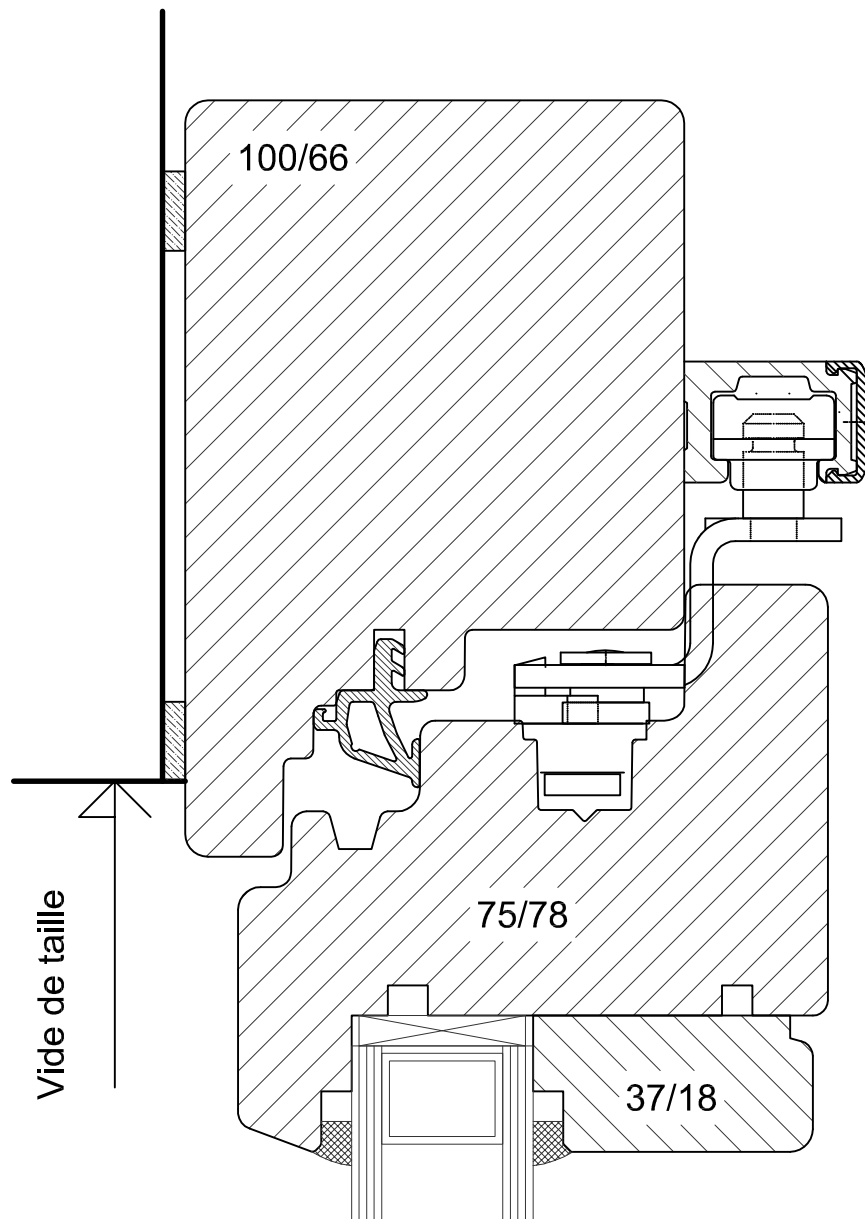

	Bois 2012 client	Echelle 1 : 1
	Traverse haute Psk 200Z plus	Date 17/02/2012
		B/66/404

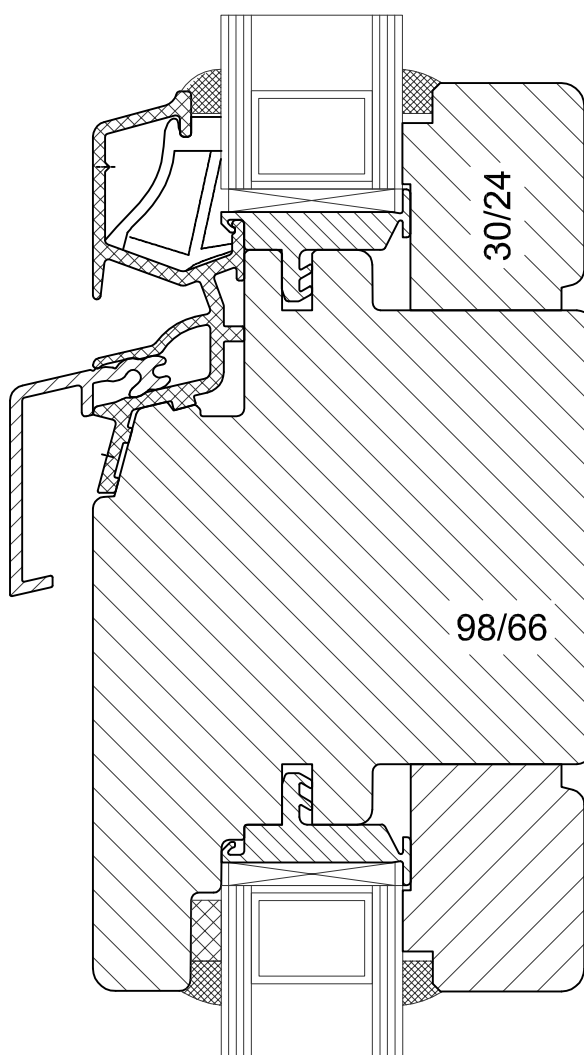

	Bois 2012 client	Echelle 1 : 1
	Traverse int. fixe dans le cadre	Date 17/02/2012
		B/66/500

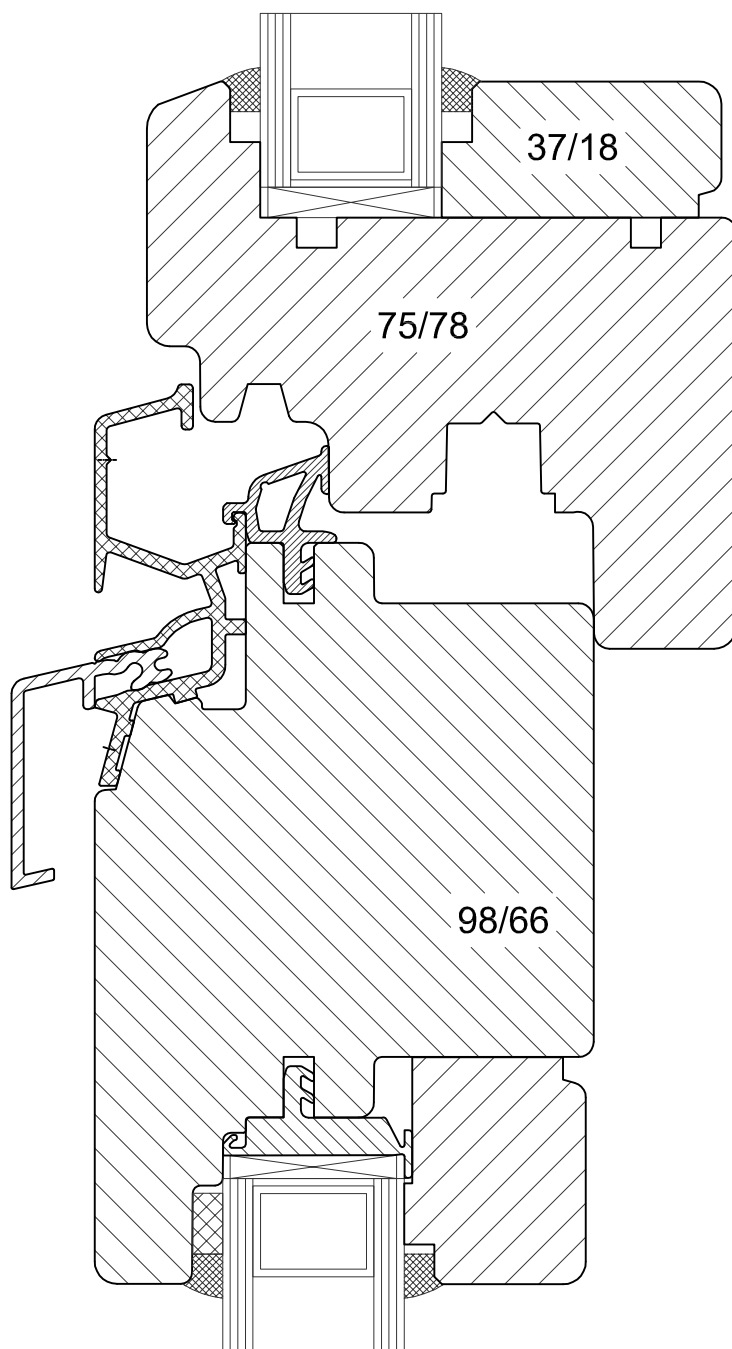

	Bois 2012 client	Echelle 1 : 1
	Traverse int. haut : guichet	Date 17/02/2012
	bas : fixe dans le cadre	B/66/501

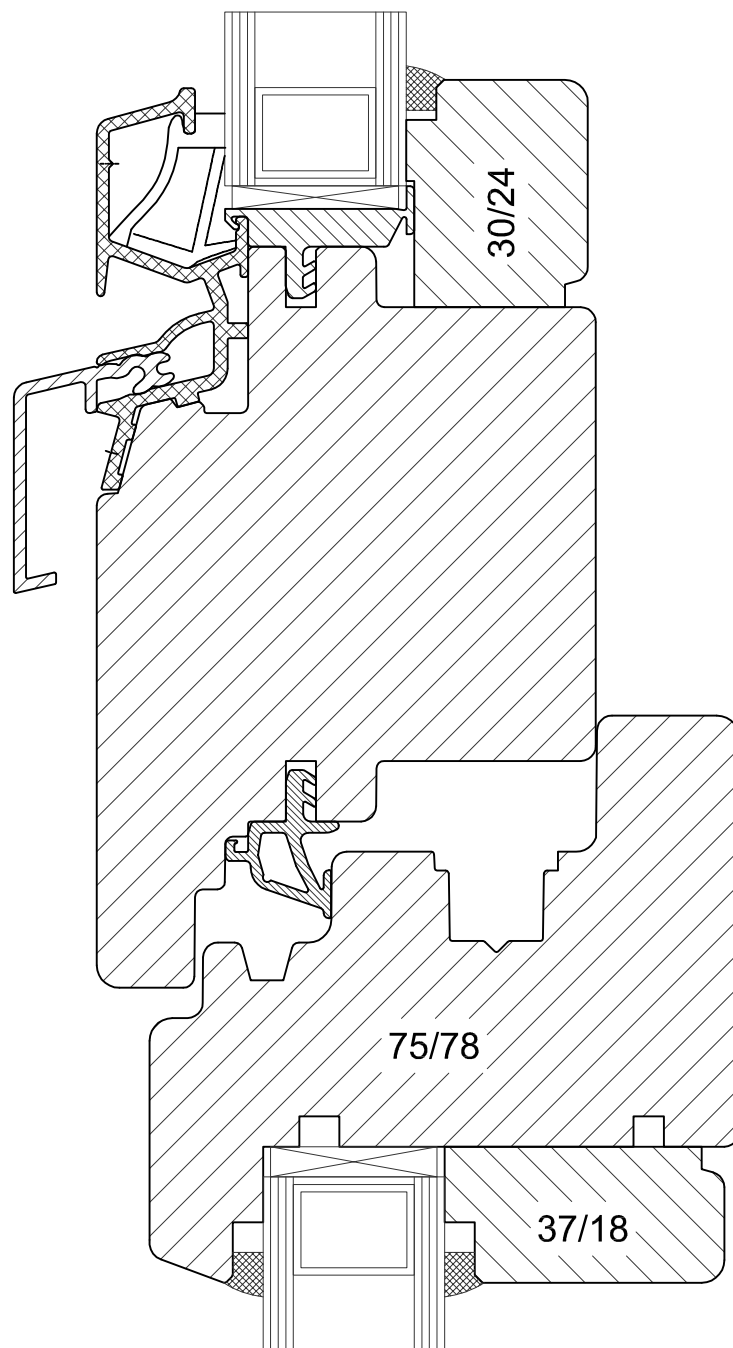

	Bois 2012 client	Echelle 1 : 1
	Traverse int. haut : fixe dans le cadre bas : quichet	Date 17/02/2012
		B/66/502

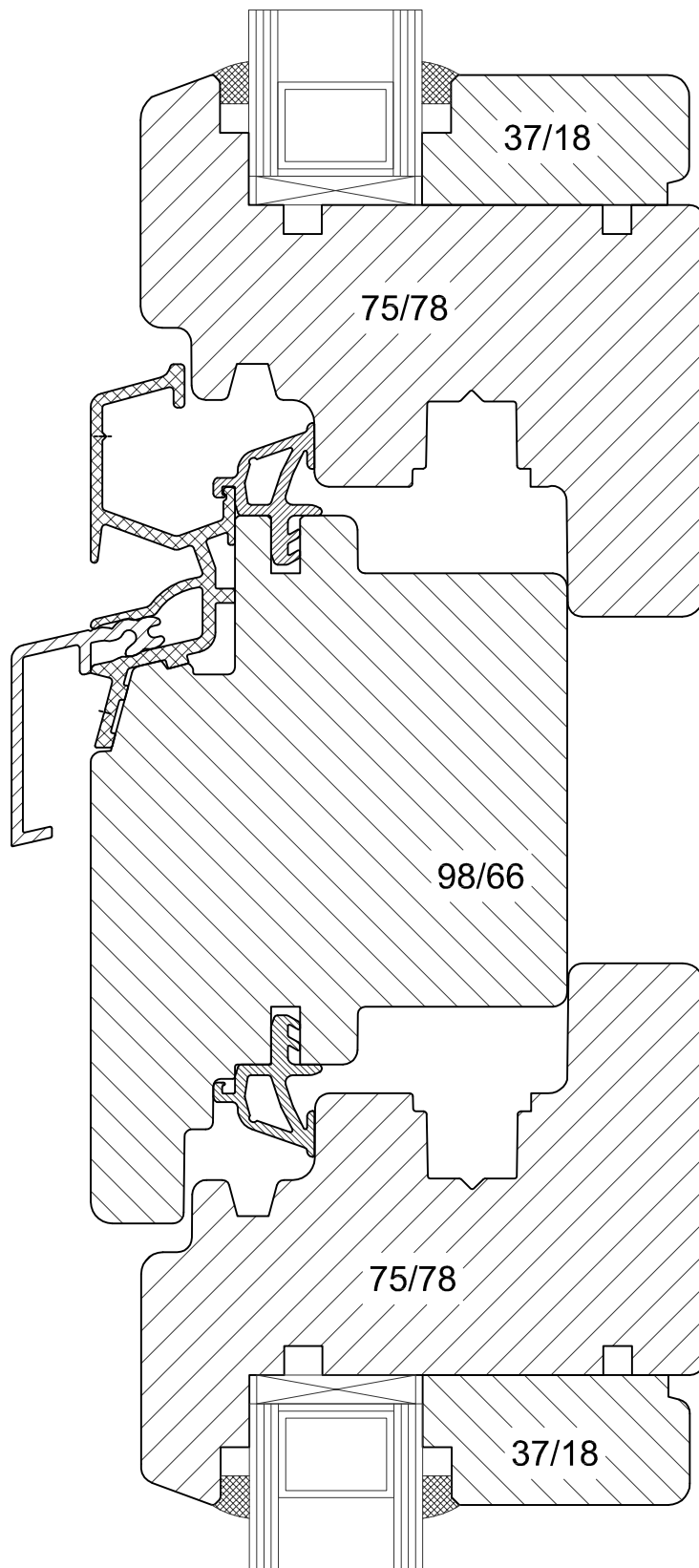



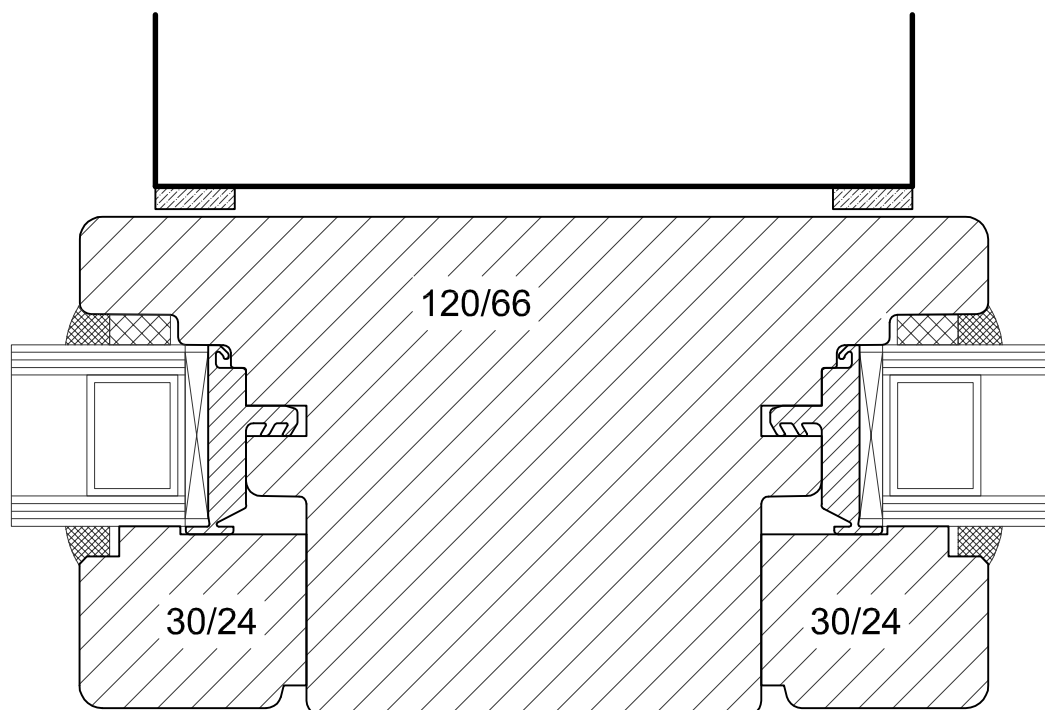

	Bois 2012 client	Echelle 1 : 1
	Montant intermédiaire gauche : fixe dans le cadre	Date 17/02/2012
	droite : fixe dans le cadre	B/66/600

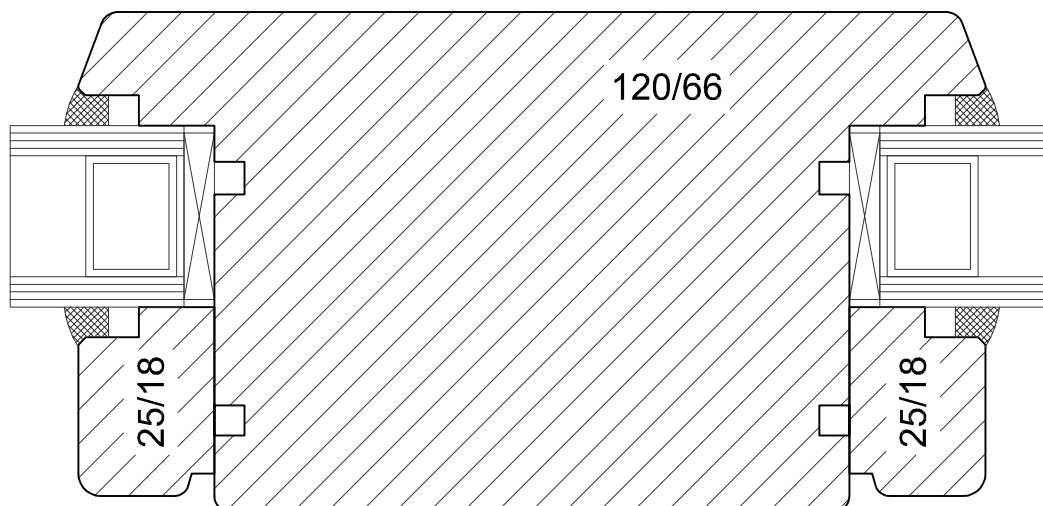

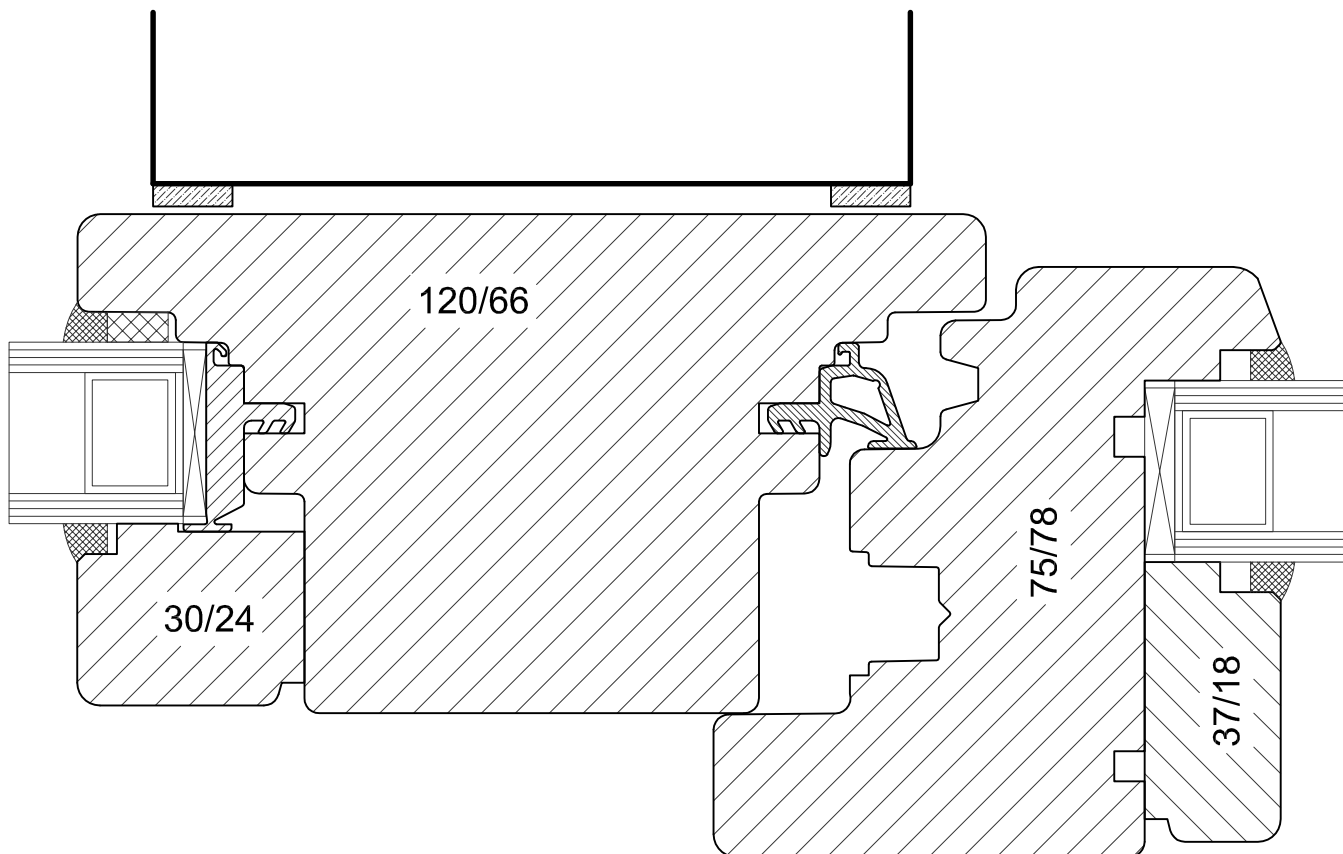

B/66/603	17/02/2012	Echelle 1 : 1
----------	------------	------------------



Bois 2012 client.dwg  
 Montants intermédiaire  
 gauche : quichet ouvrant  
 droite : quichet ouvrant

Echelle 1 : 1	Date 17/02/2012
B/66/603	

