

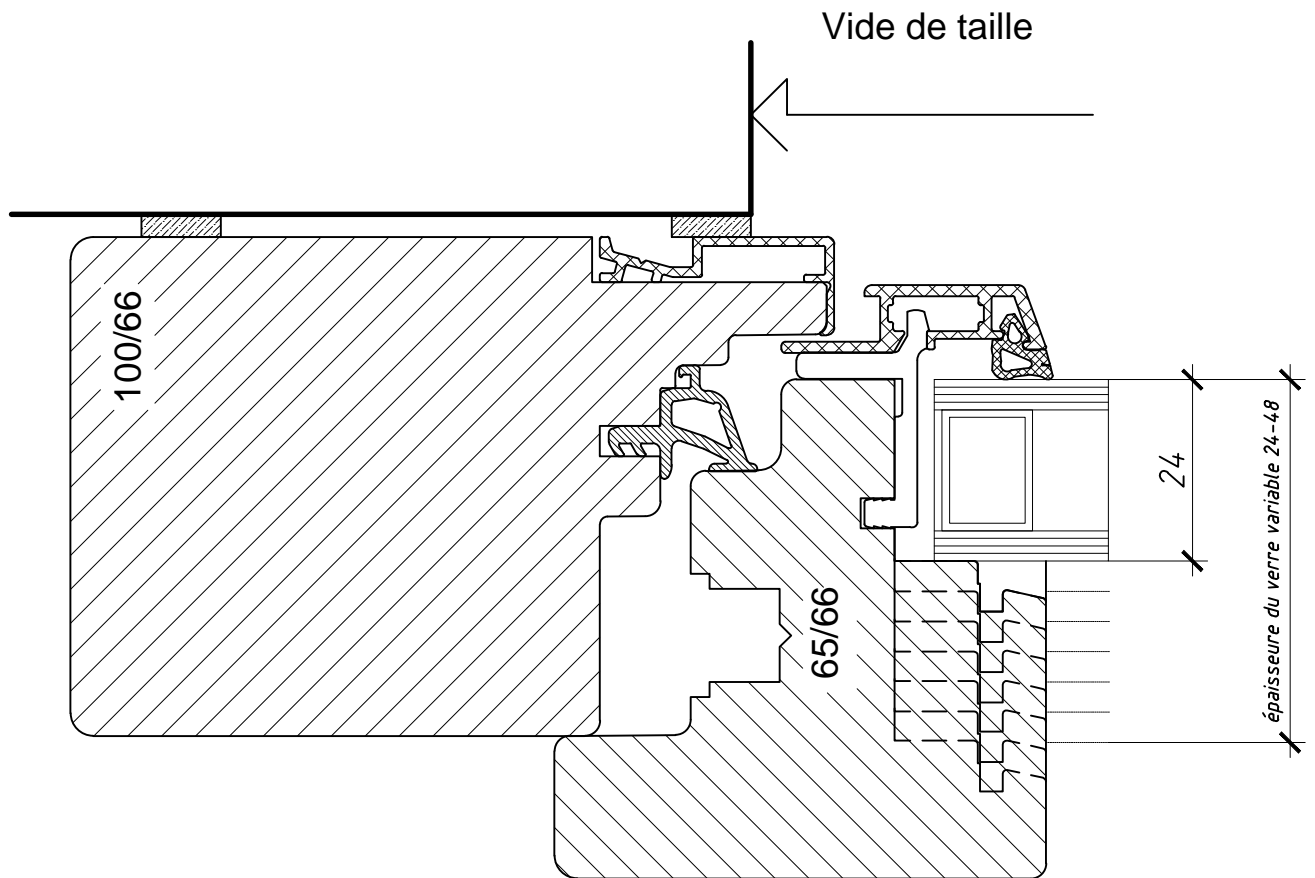

	Bois-Métal 2012 client	Echelle 1 : 1
	Fixe dans le cadre	Date 21/09/2012
		BM/66/100



	Bois-Métal 2012 client	Echelle 1 : 1
	Montant standard	Date 21/09/2012
		BM/66/102

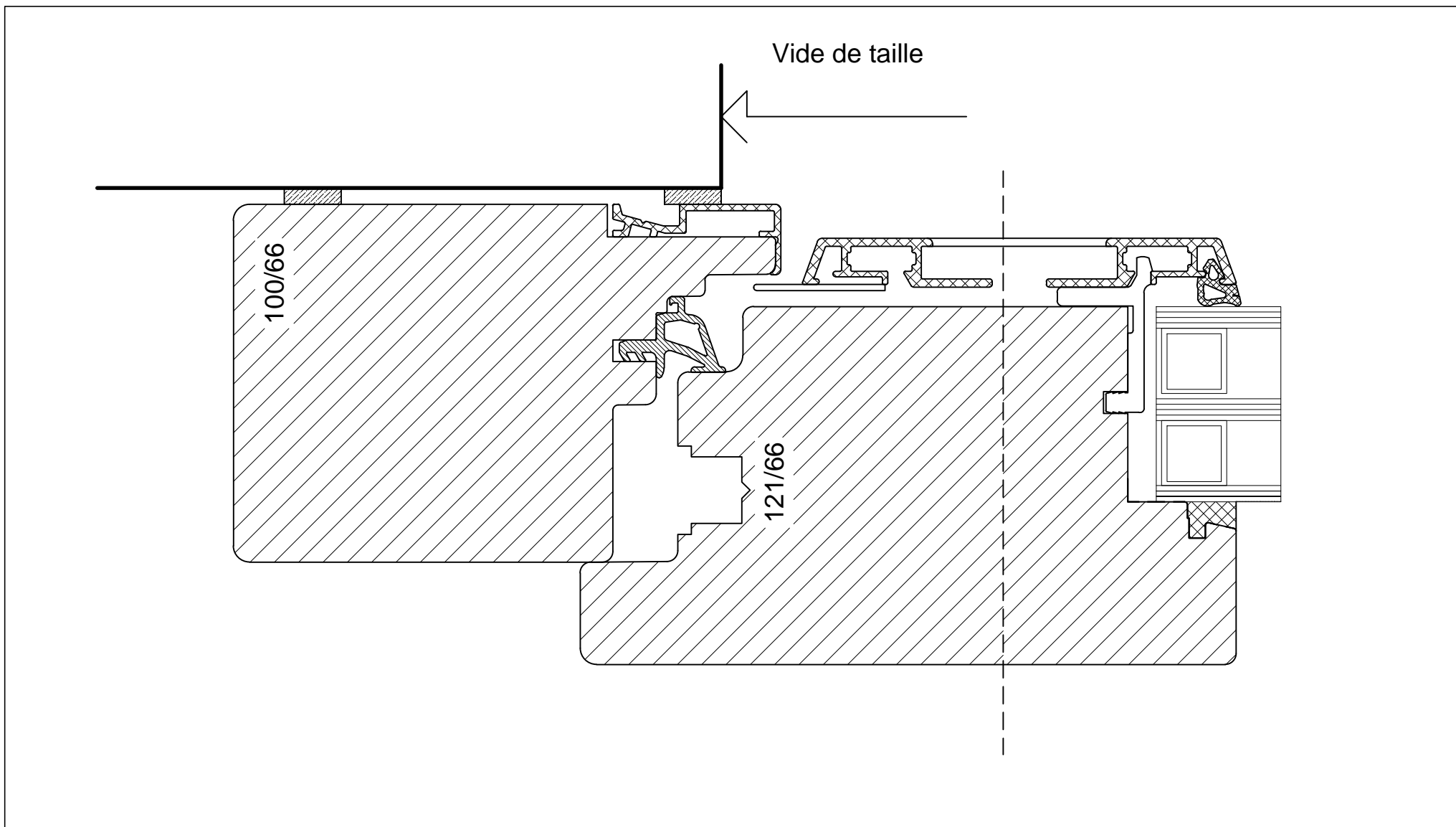

Echelle 1 : 1
Date 21/09/2012
BM/66/103



Bois-Métal 2012 client.dwg

Montants Porte multipoint, balcover poignée
traversante

Echelle
1 : 1

Date
21/09/201

BM/66/

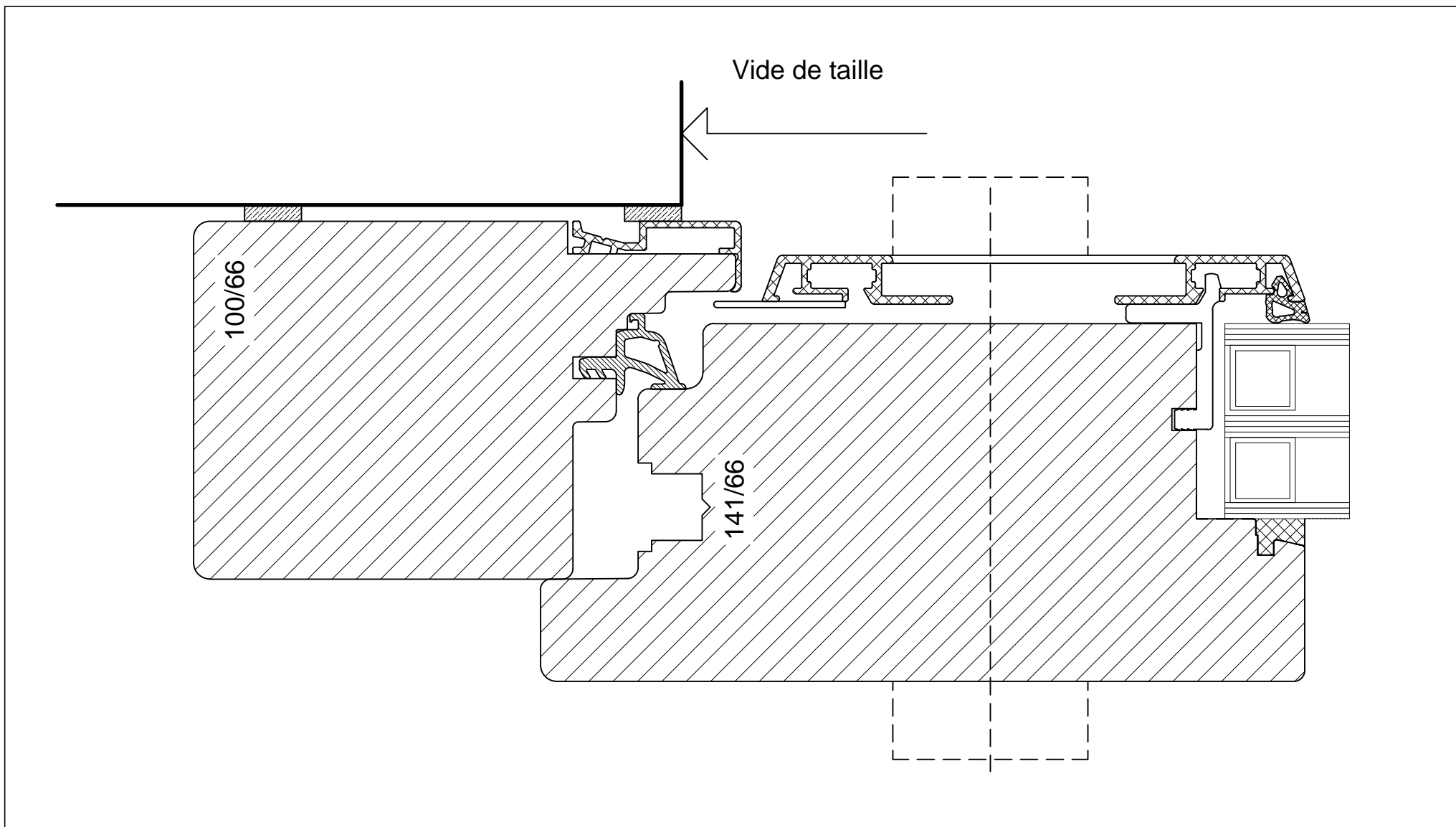

Echelle 1 : 1
Date 21/09/2012
BM/66/104



Bois-Métal 2012 client.dwg	Echelle 1 : 1
Montants Porte entrée poignée traversante	Date 21/09/2012
	BM/66/

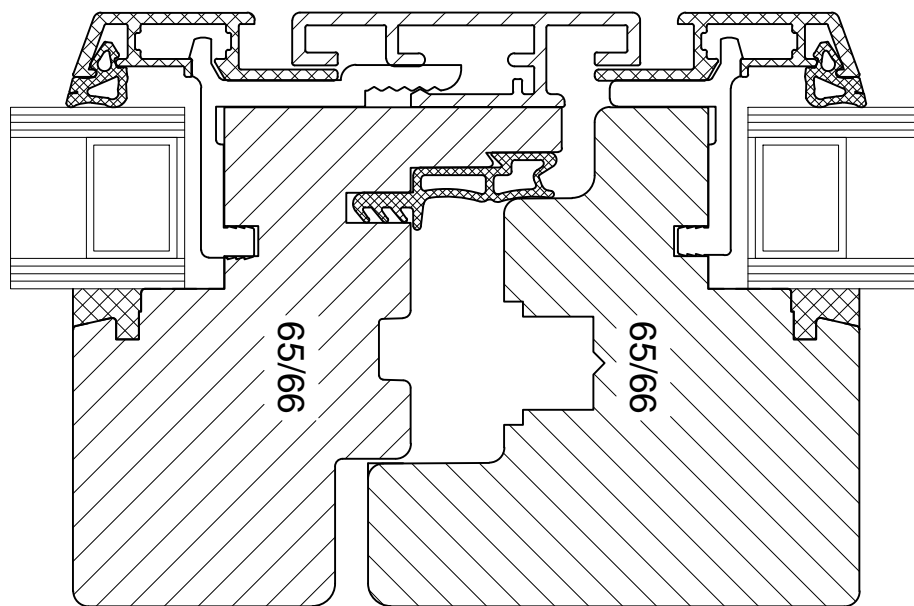

	Bois-Métal 2012 client	Echelle 1 : 1
	Montants central	Date 21/09/2012
		BM/66/200

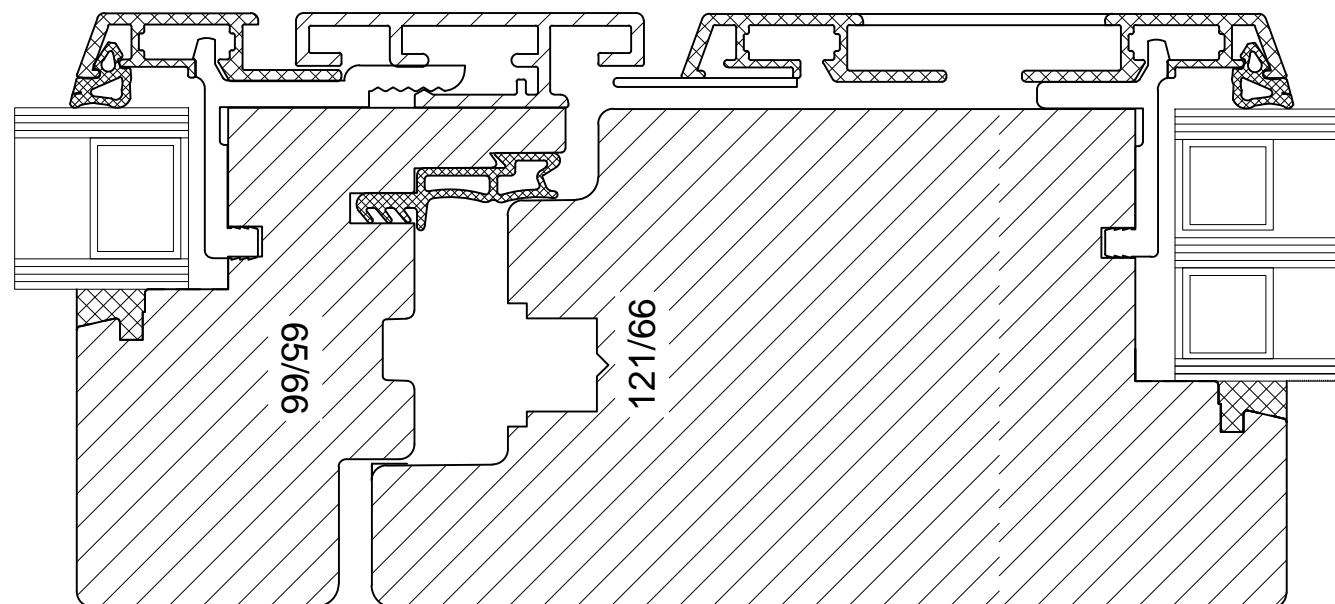

Echelle 1 : 1
Date 15/12/2014
BM/66/201



Bois-Métal 2012 client.dwg

Montants Centrale poignée traversante

Echelle
1 : 1

Date
15/12/201

BM/66/

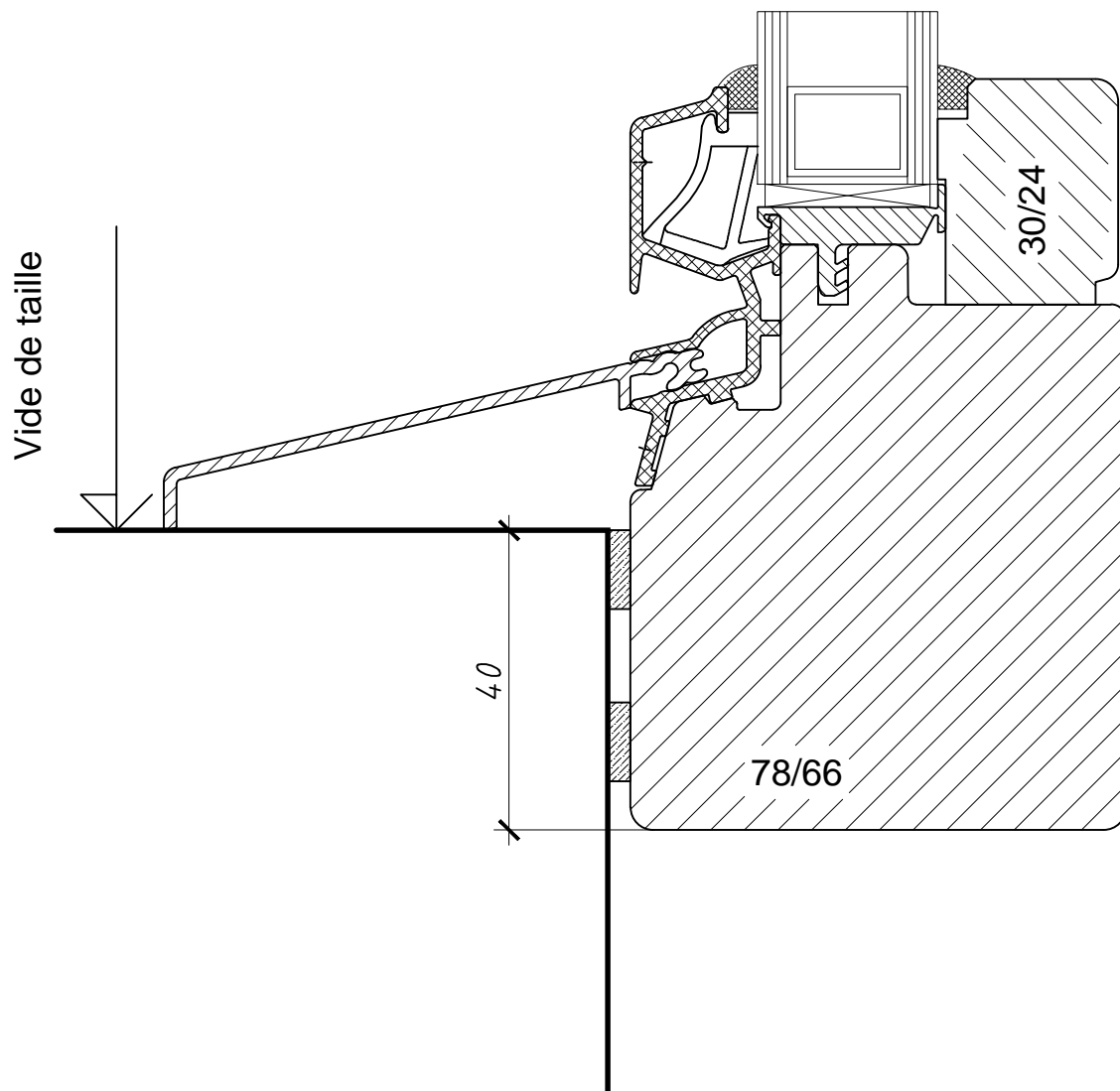

Bois-Métal 2012 client

Fixe dans le cadre

Echelle
1 : 1

Date
15/12/2014

BM/66/300

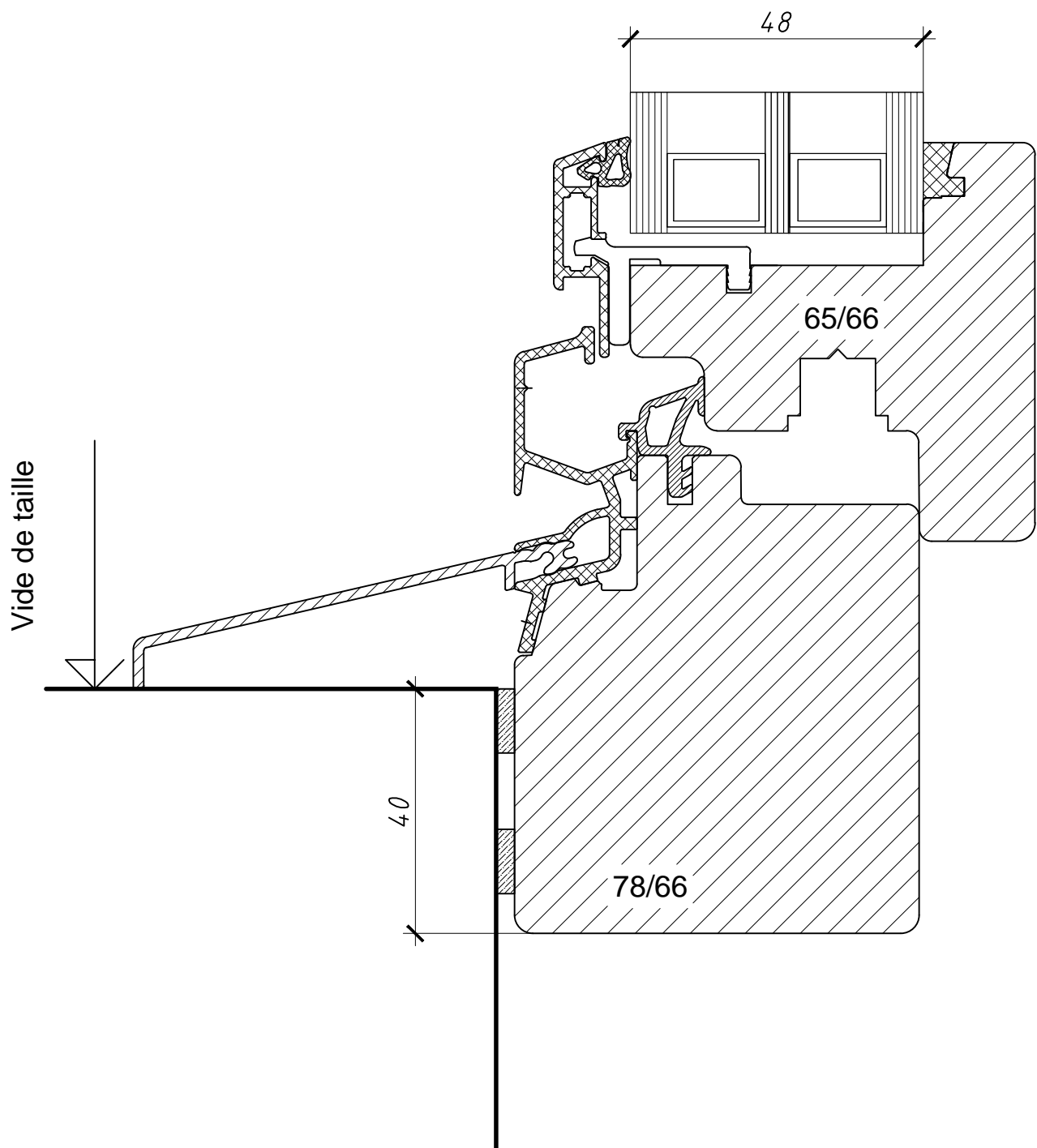

	Bois-Métal 2012 client	Echelle 1 : 1
	Traverse basse standard	Date 15/12/2014
		BM/66/302

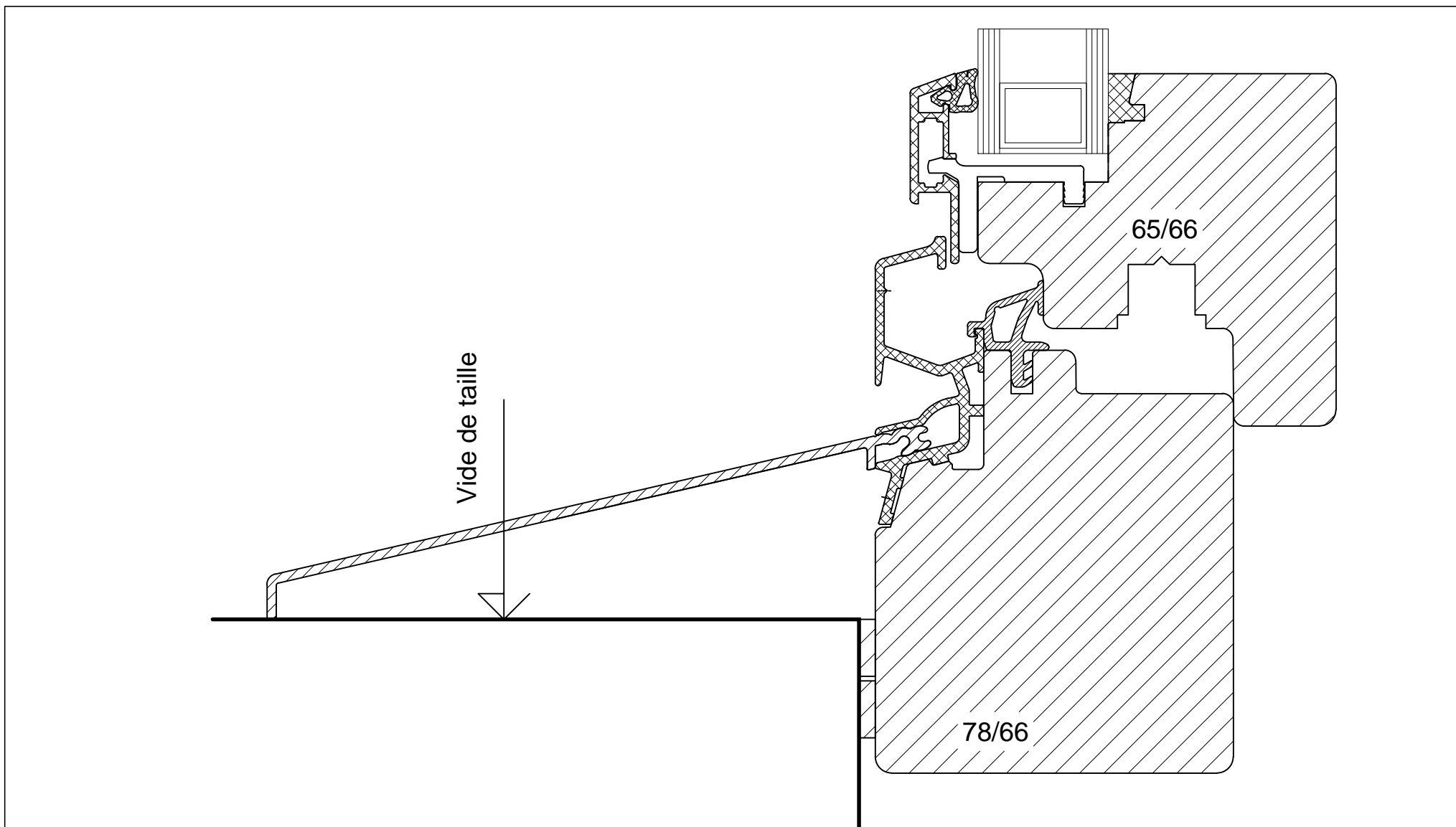

Echelle 1 : 1
Date 15/12/2014
BM/66/303



Bois-Métal 2012 client.dwg

Traverse basse rvd'eau 115mm

Echelle
1 : 1

Date
15/12/2014

BM/66/

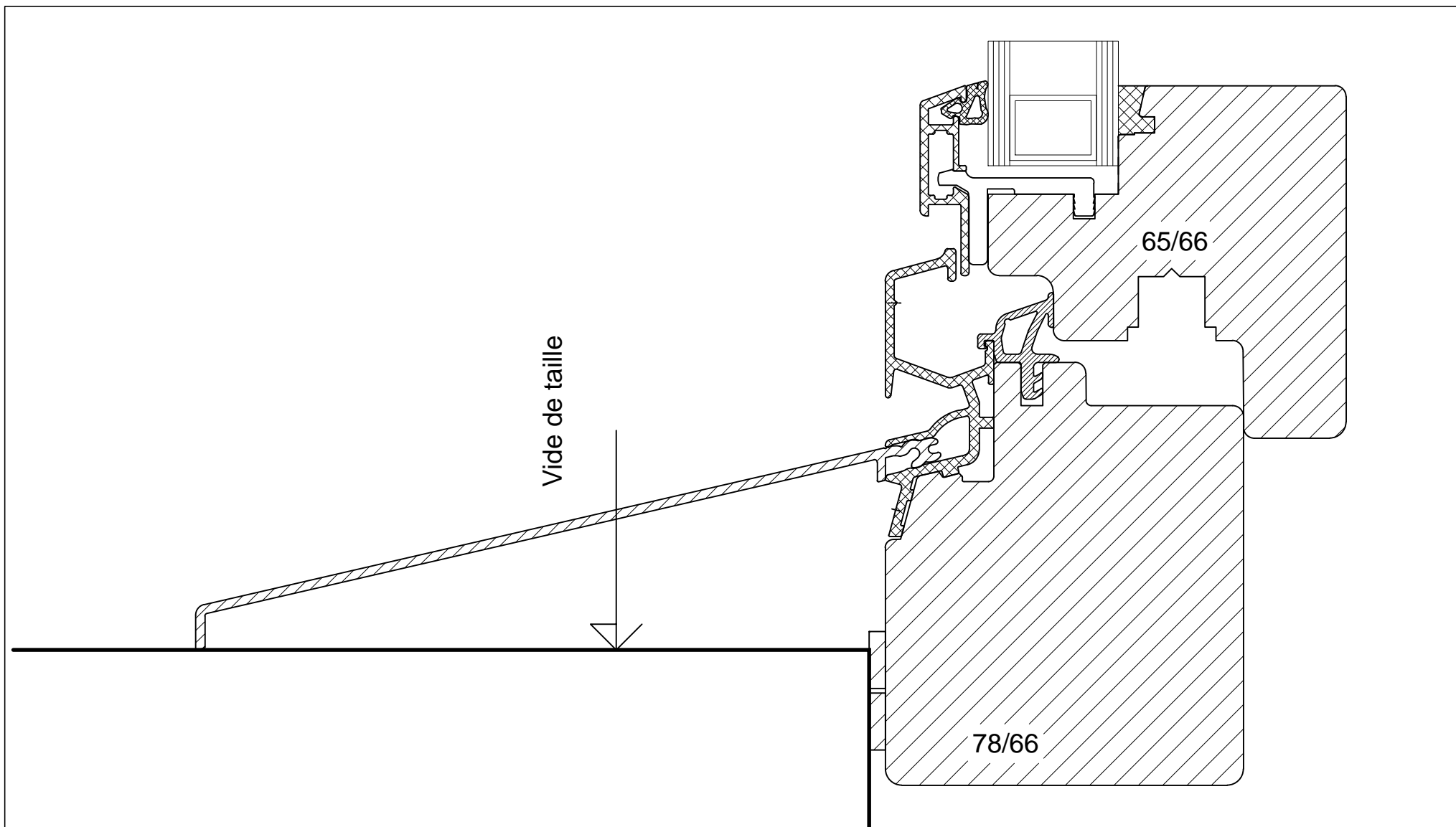

Echelle 1 : 1
Date 15/12/2014
BM/66/304



Bois-Métal 2012 client.dwg

Traverse basse rvd'eau 130mm

Echelle
1 : 1

Date
15/12/2014

BM/66/

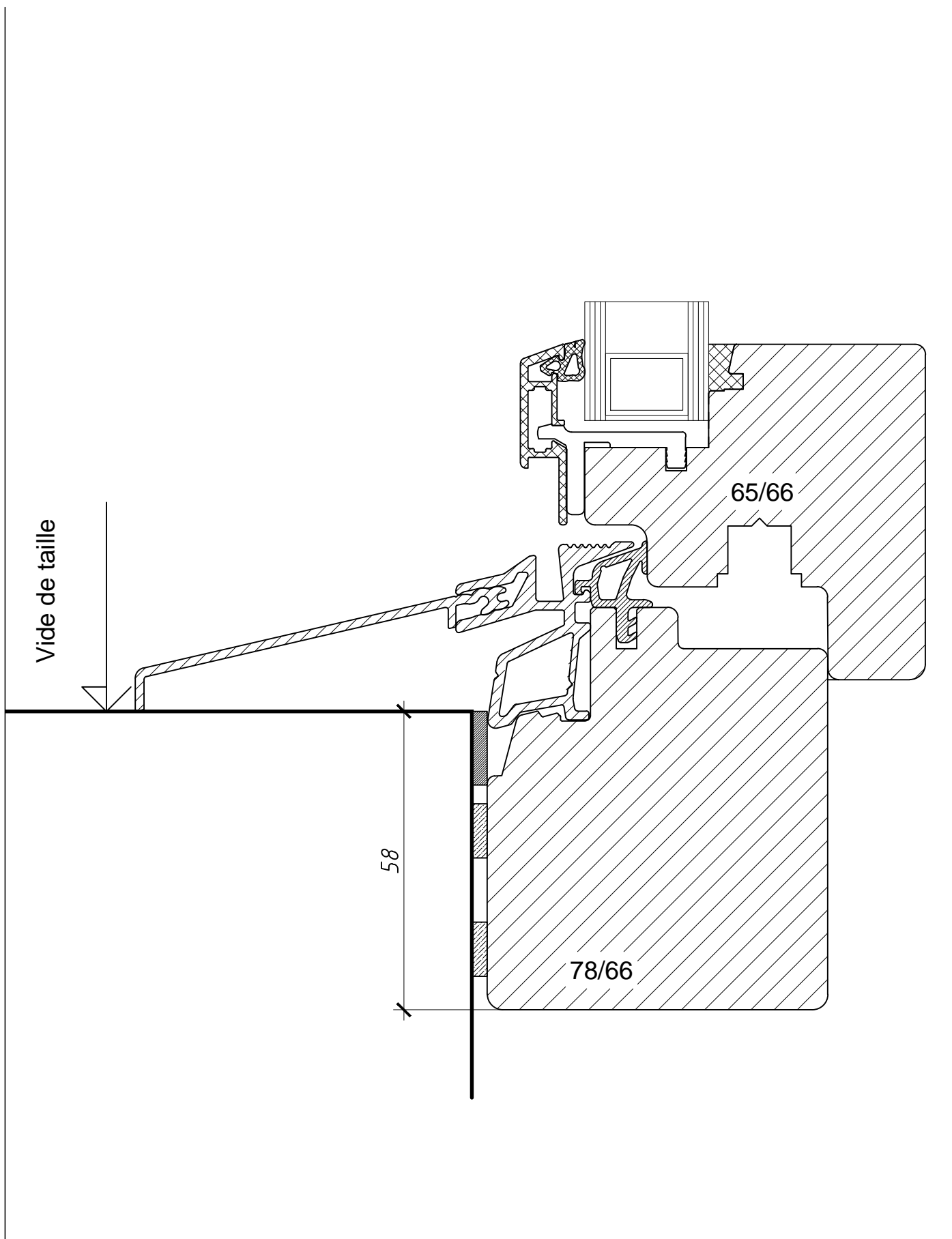

	Bois-Métal 2012 client	Echelle 1 : 1
	Traverse basse seuil minimum	Date 15/12/2014
		BM/66/305

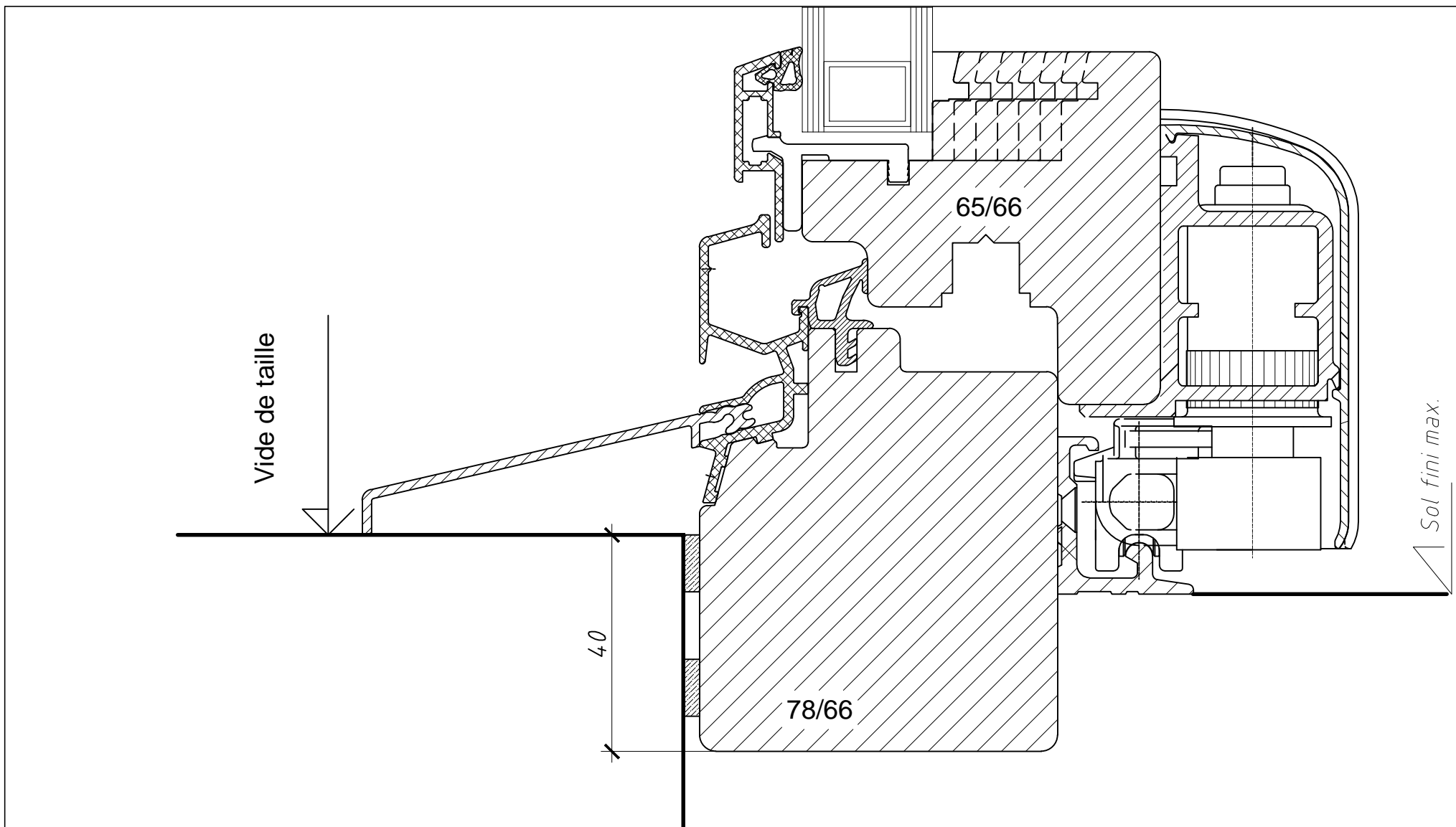

Echelle 1 : 1
Date 15/12/2014
BM/66/307



Bois-Métal 2012 client.dwg

Traverse basse Psk-200Z plus

Echelle
1 : 1

Date
15/12/2014

BM/66/

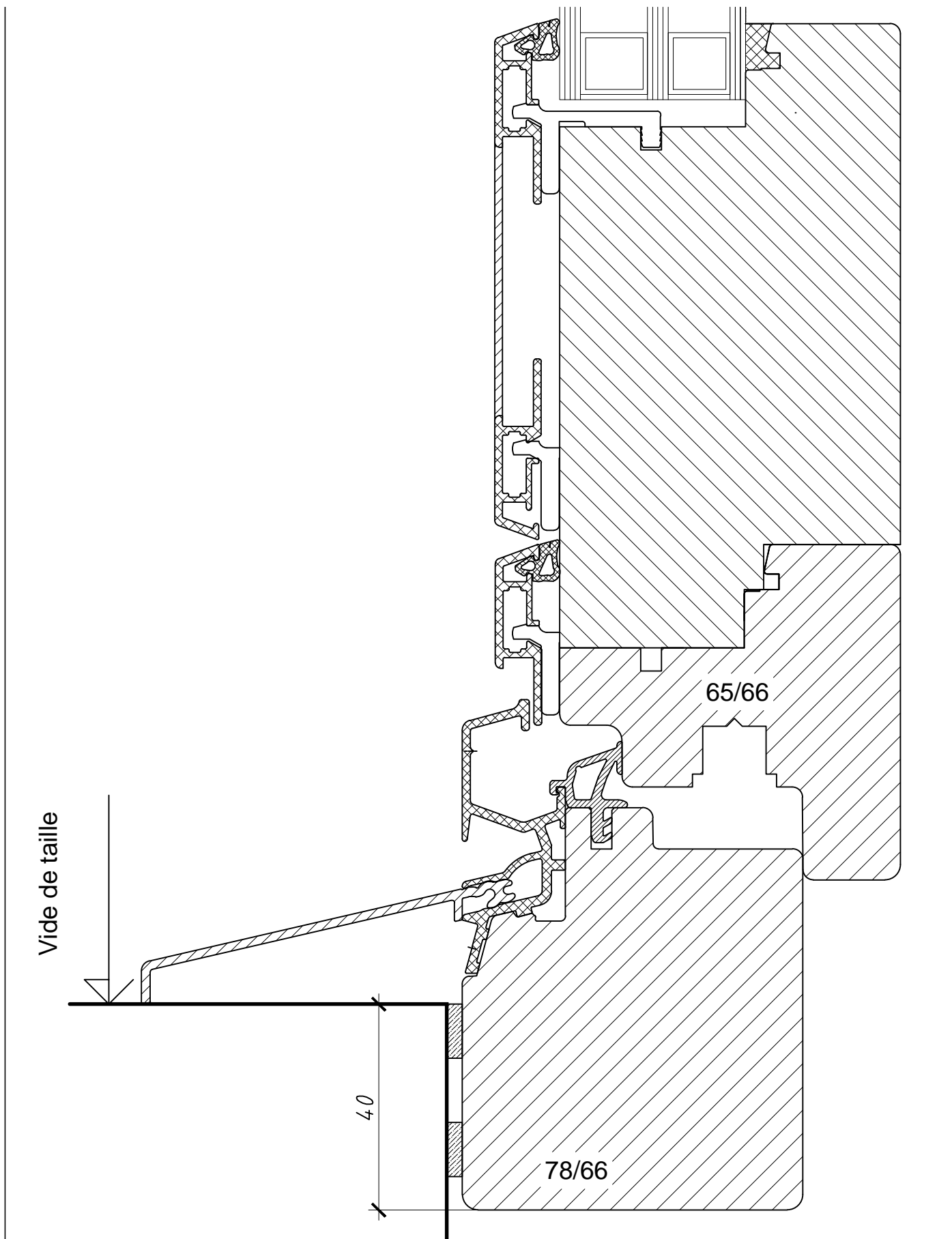

	Bois-Métal 2012 client	Echelle 1 : 1
	Traverse basse porte balcon avec remplissage	Date 15/12/2014
		BM/66/308

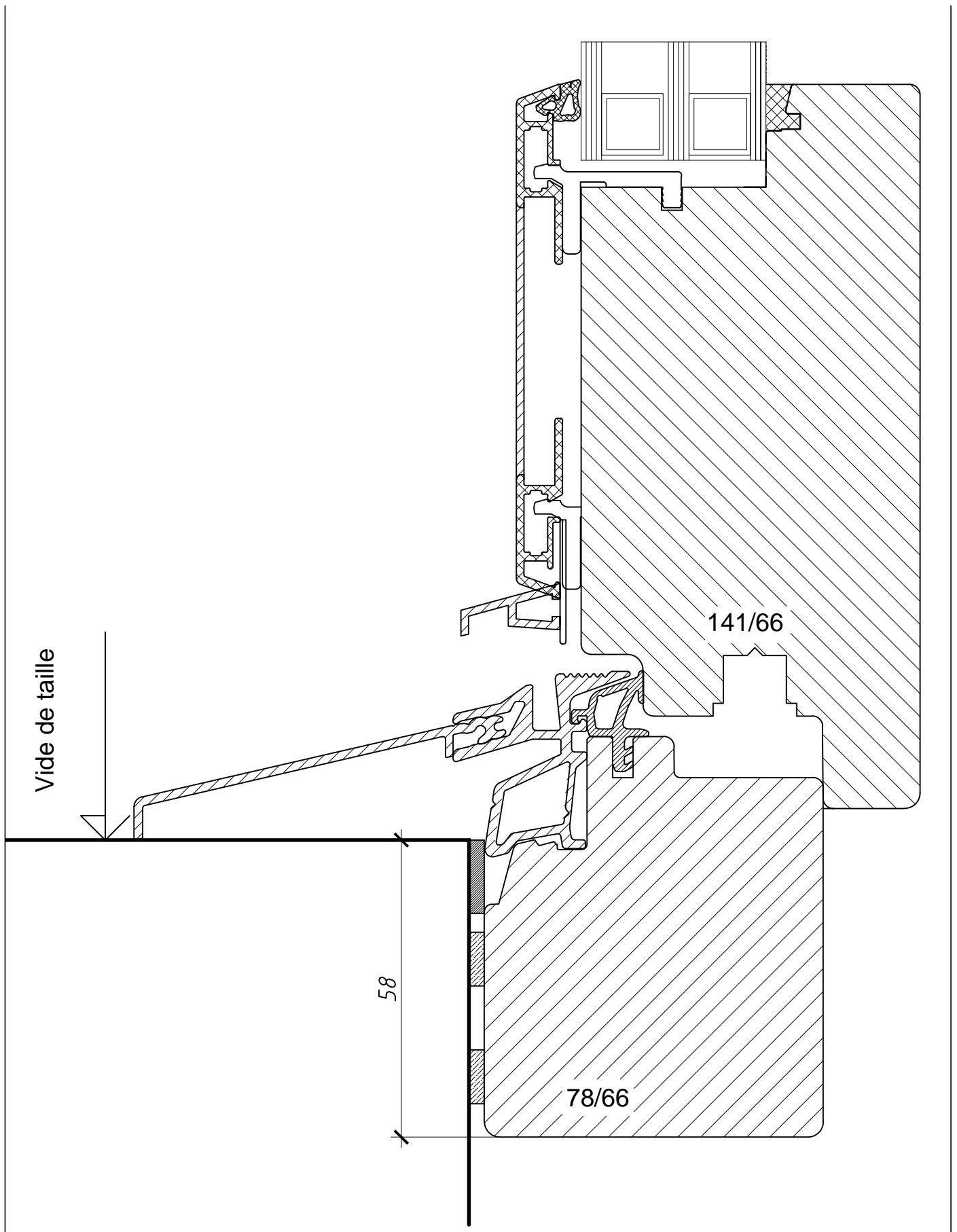

	Bois-Métal 2012 client	Echelle 1 : 1
	Traverse basse porte Entrée seuil min	Date 15/12/2014
		BM/66/309

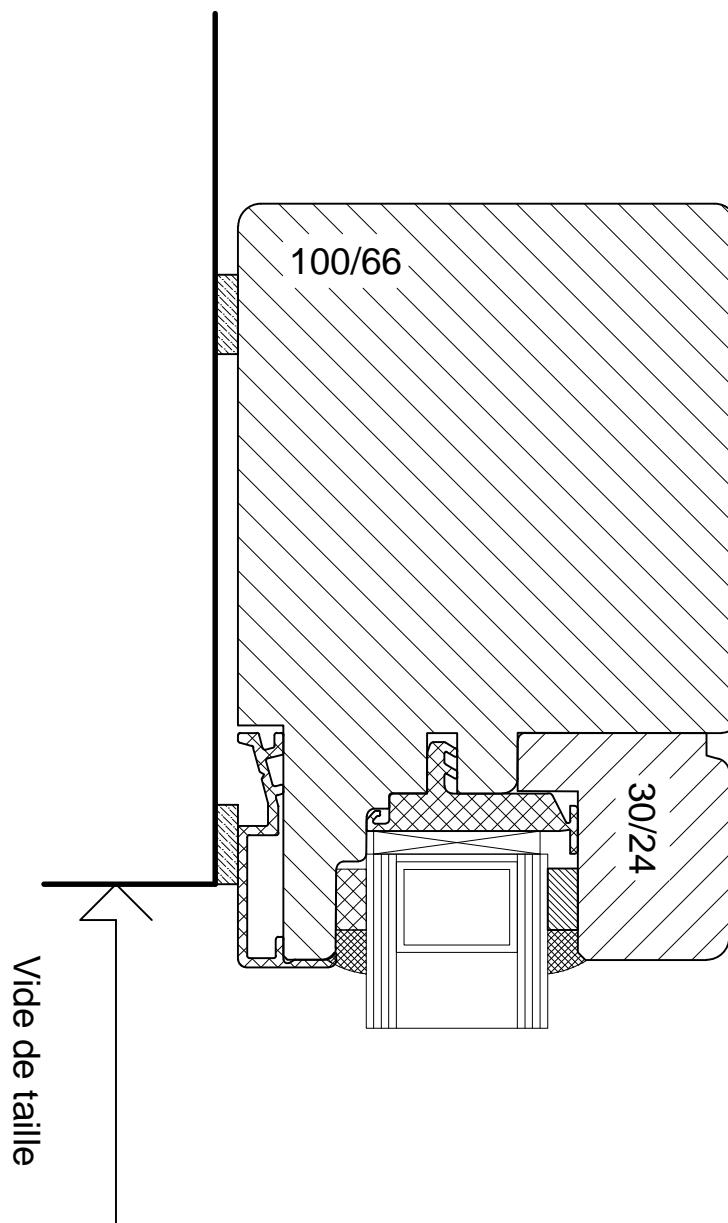

Bois-Métal 2012 client	Echelle 1 : 1
Traverse haute fixe dans le cadre	Date 15/12/2014
	BM/66/400

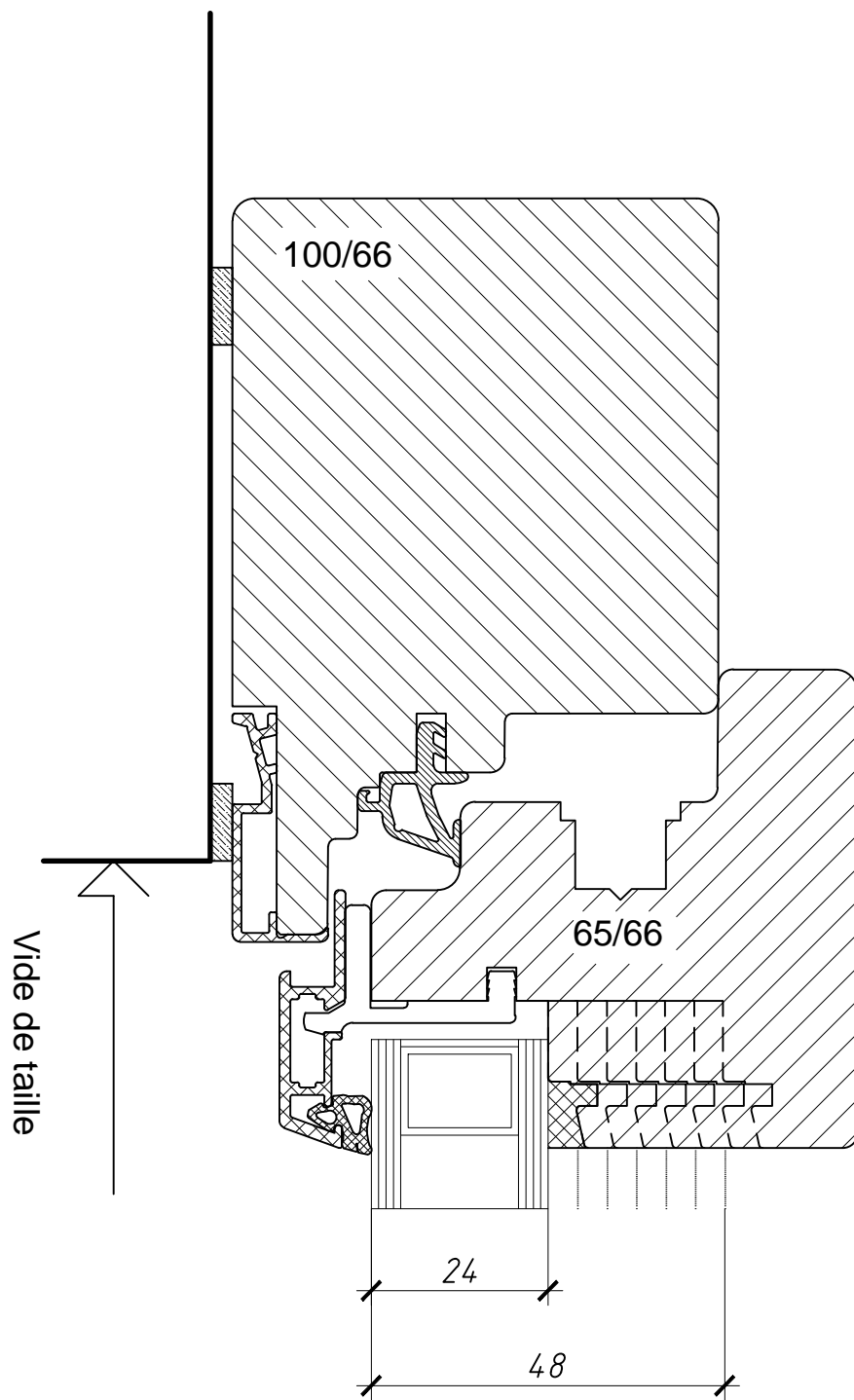

	Bois-Métal 2012 client	Echelle 1 : 1
	Traverse haute standard	Date 15/12/2014
		BM/66/402

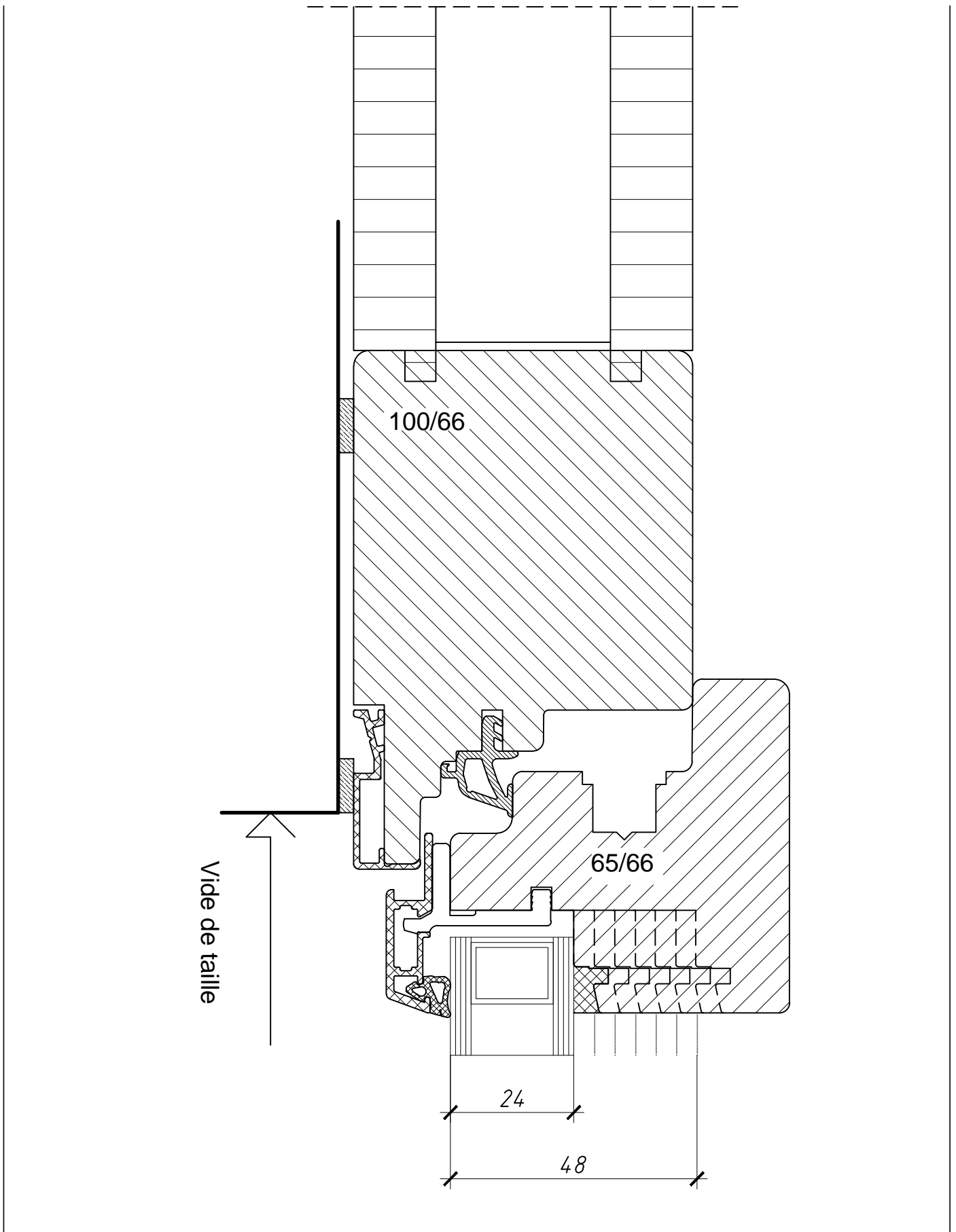

	Bois-Métal 2012 client	Echelle 1 : 1
	Traverse haute standard attique	Date 15/12/2014
		BM/66/403

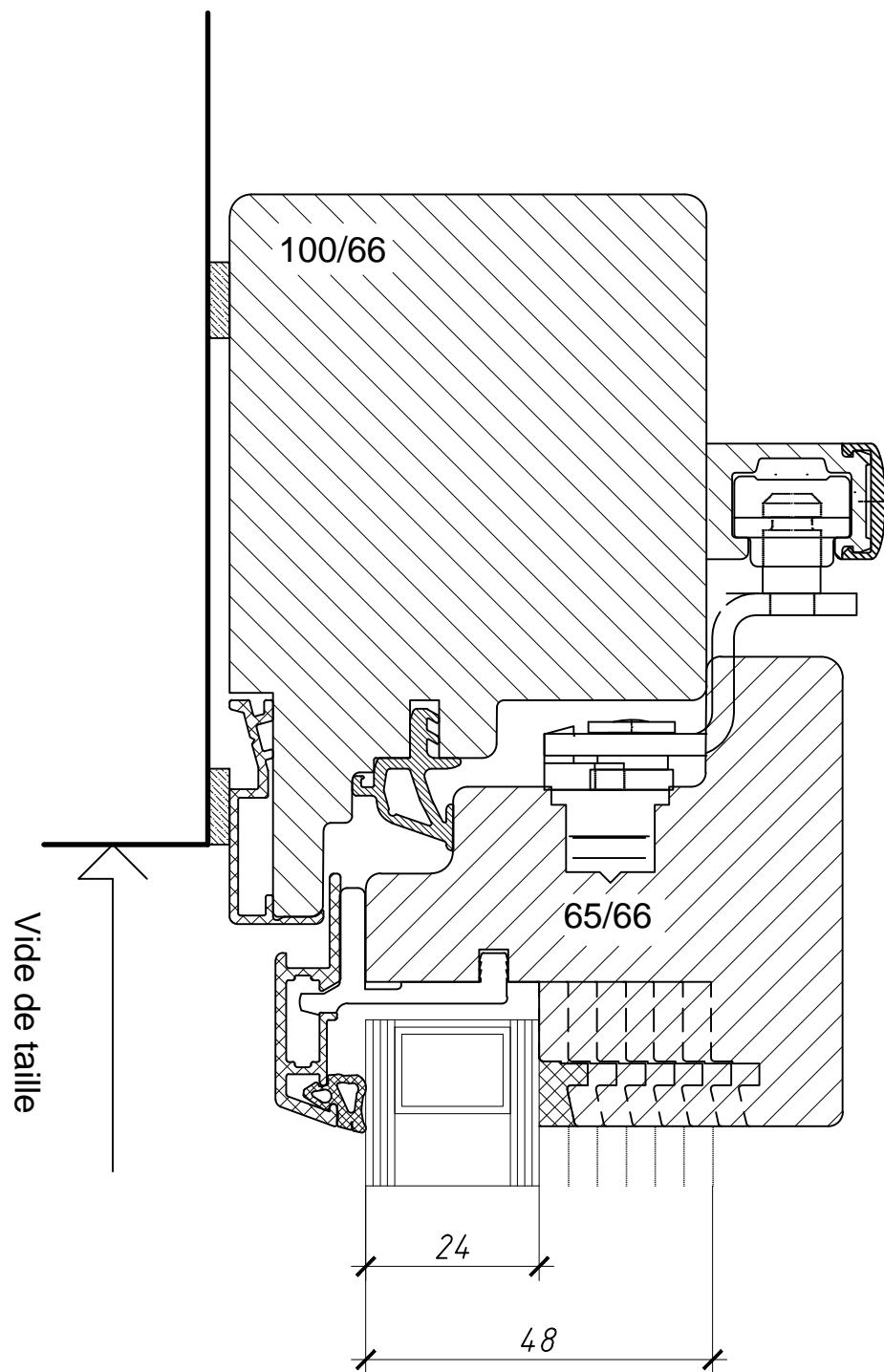

	Bois-Métal 2012 client	Echelle 1 : 1
	Traverse haute Psk 200Z plus	Date 15/12/2014
		BM/66/404

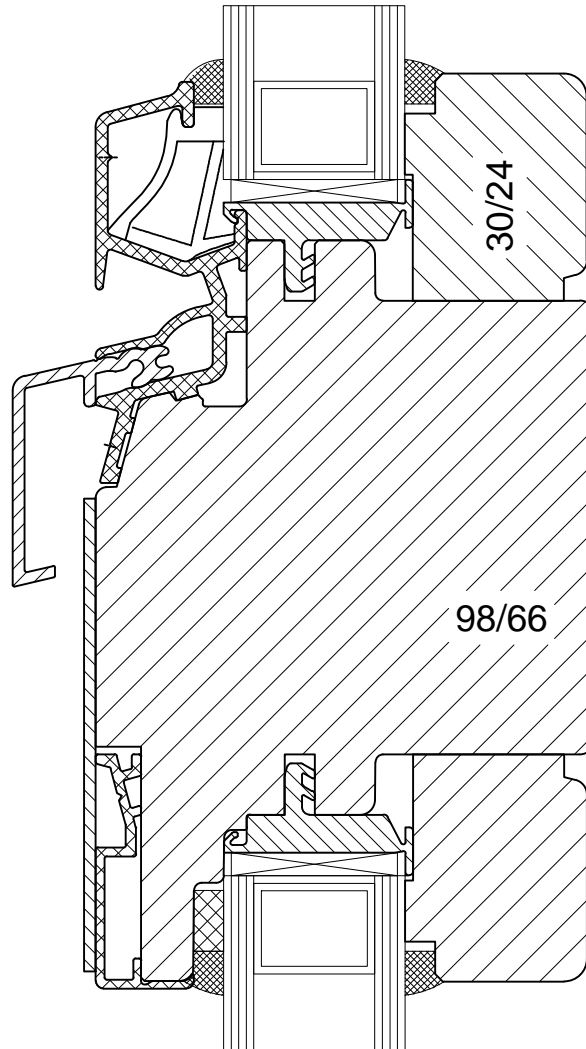

Bois-Métal 2012 client

Traverse int. fixe dans le cadre

Echelle
1 : 1

Date
15/12/2014

BM/66/500

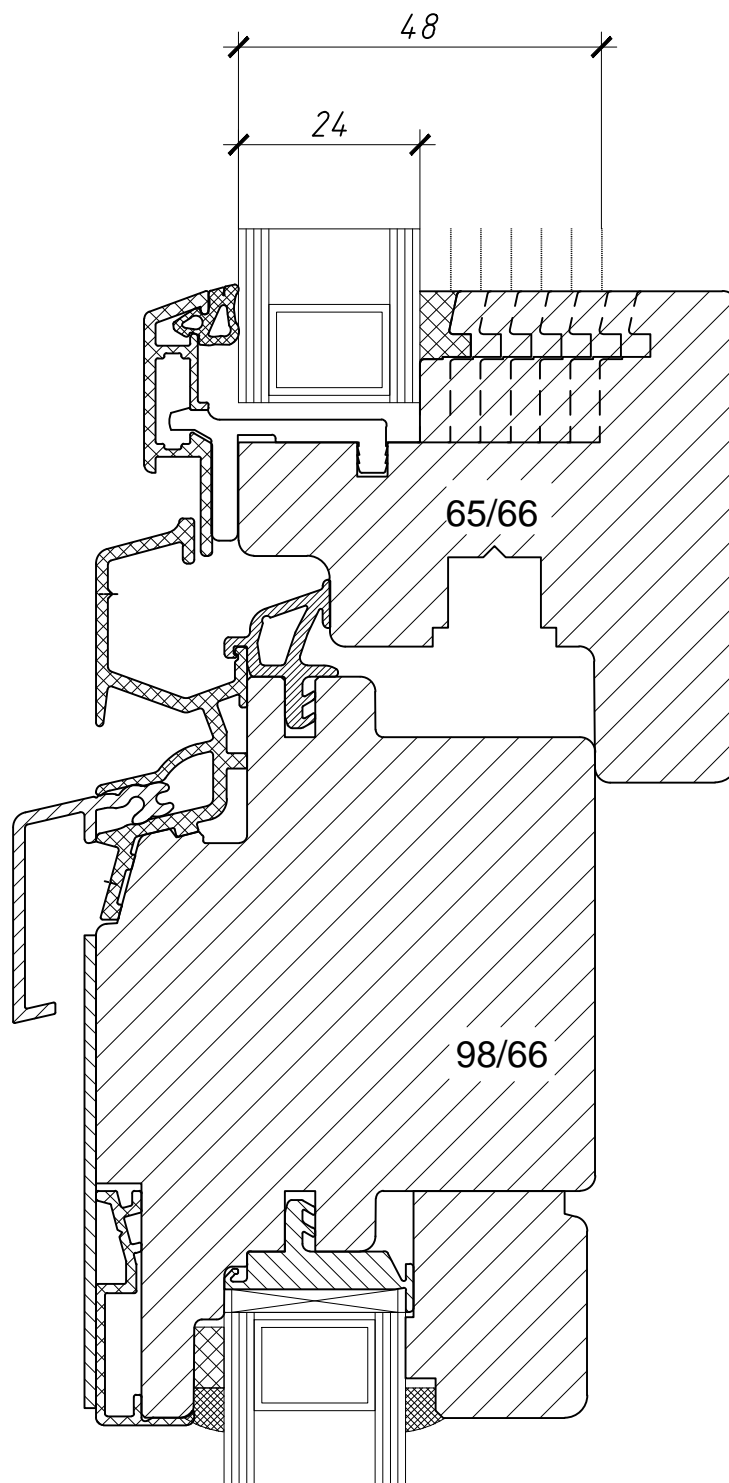

Bois-Métal 2012 client	Echelle 1 : 1
Traverse int. haut : guichet	Date 15/12/2014
bas : fixe dans le cadre	BM/66/501

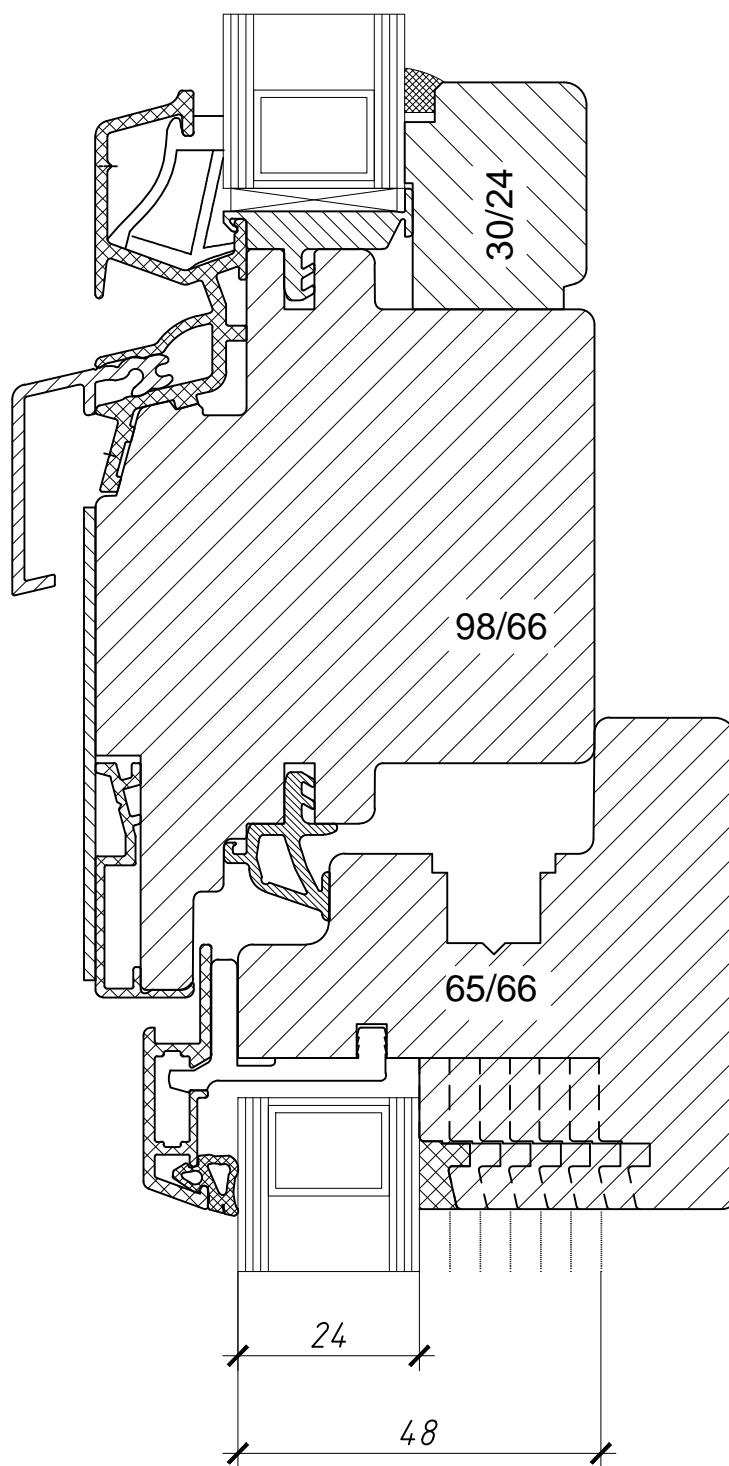

Bois-Métal 2012 client

Traverse int.
 haut : fixe dans le cadre
 bas : guichet

Echelle
 1 : 1

Date
 15/12/2014

BM/66/502

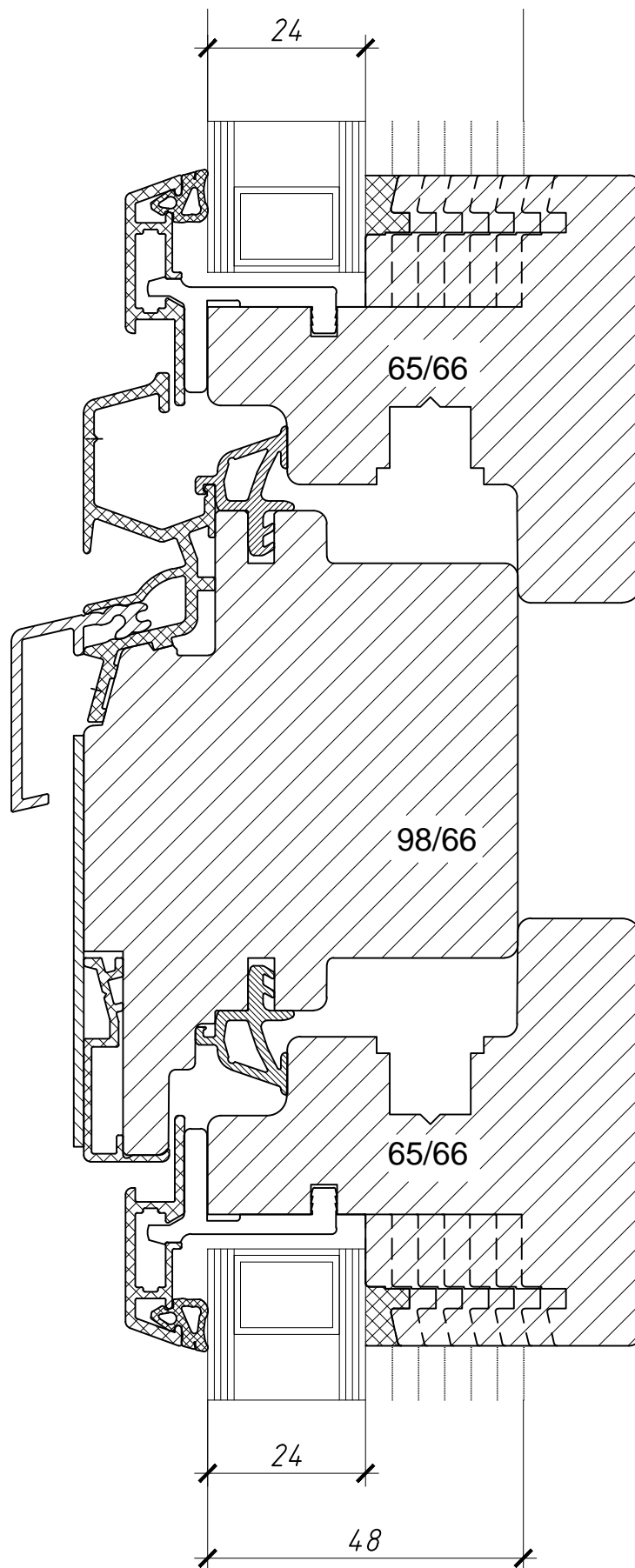

Bois-Métal 2012 client

Traverse int.
 haut : guichet
 bas : guichet

Echelle
 1 : 1

Date
 15/12/2014

BM/66/503

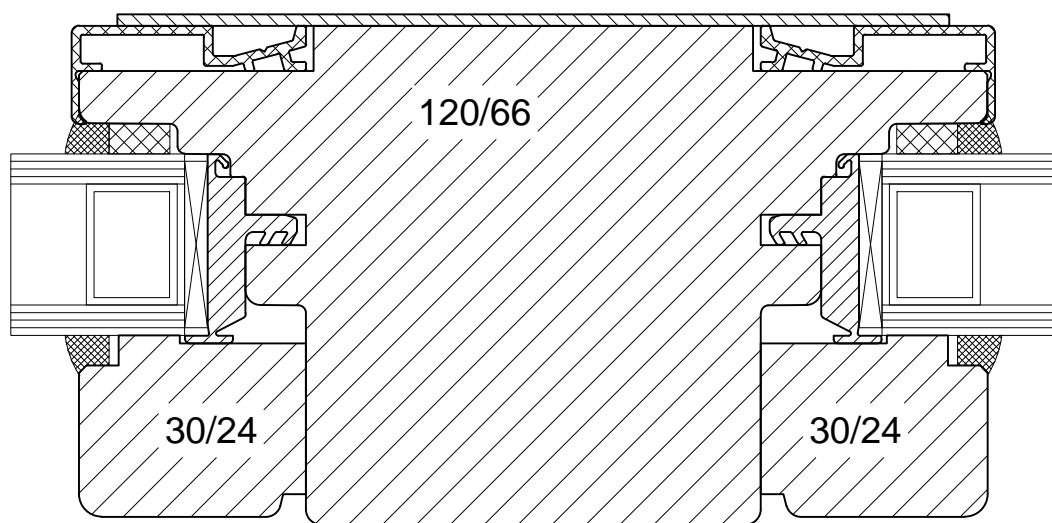

	Bois-Métal 2012 client	Echelle 1 : 1
	Montant intermédiaire gauche : fixe dans le cadre droite : fixe dans le cadre	Date 15/12/2014
		BM/66/600

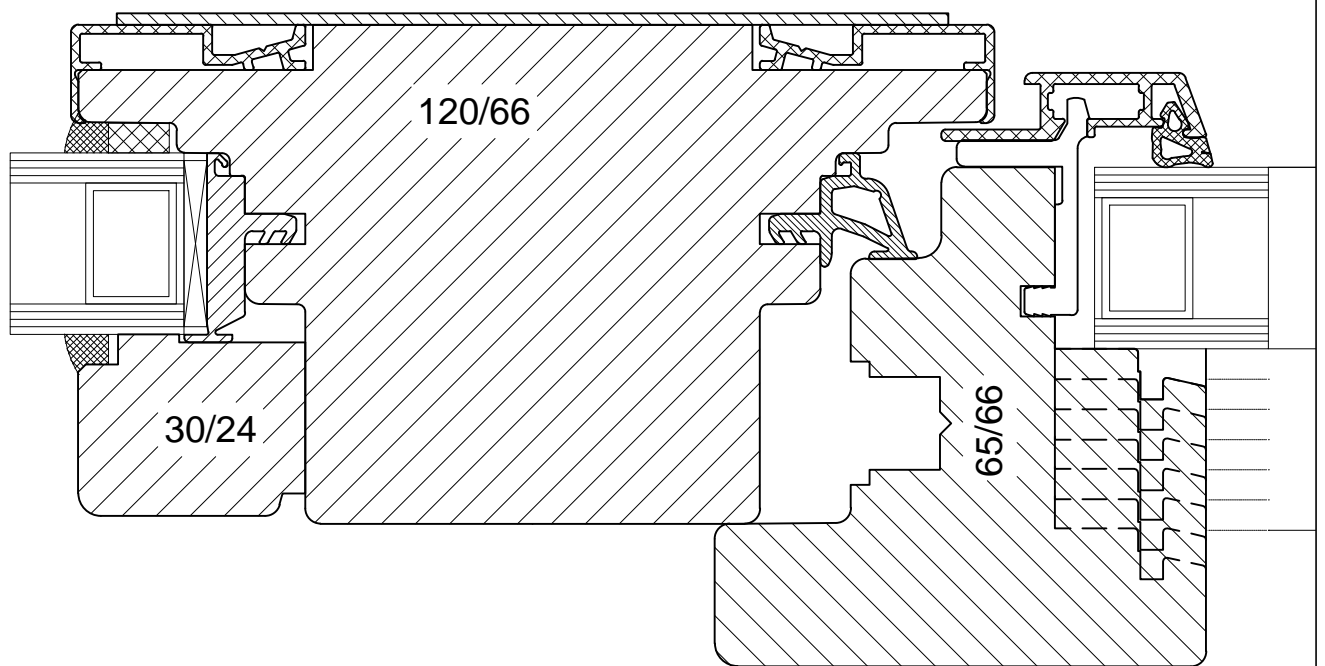

	Bois-Métal 2012 client	Echelle 1 : 1
	Montant intermédiaire gauche : fixe dans le cadre droite : guichet ouvrant	Date 15/12/2014
	BM/66/602	

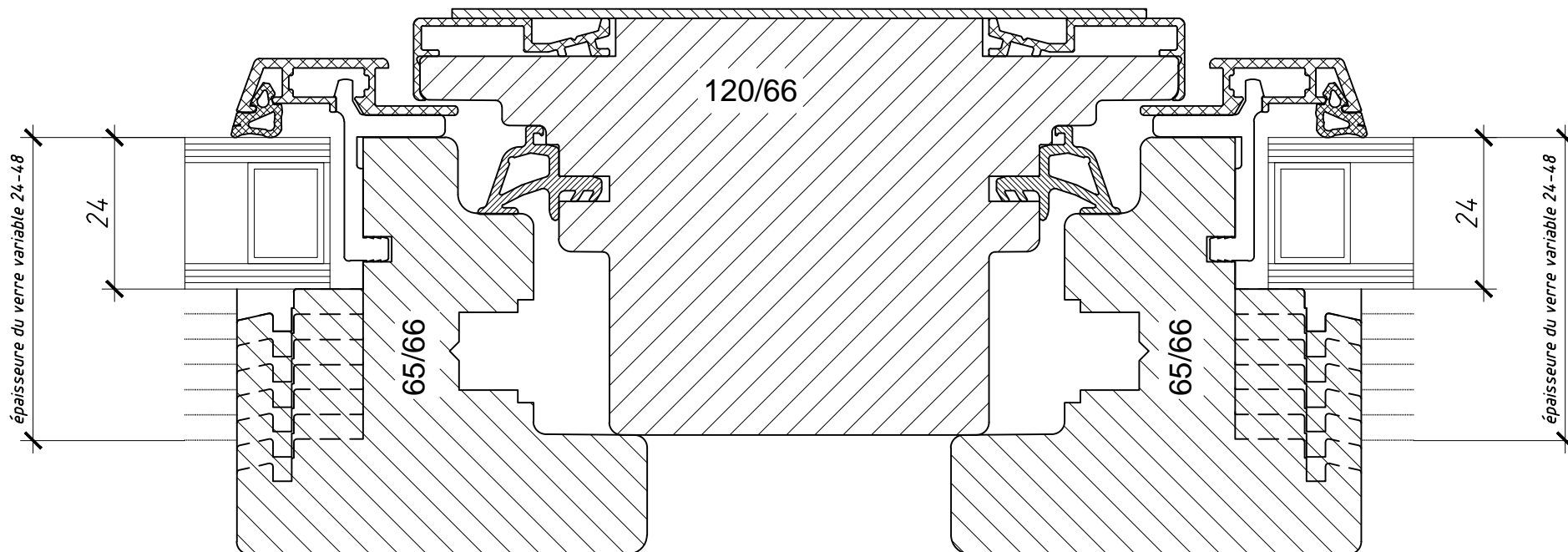

BM/66/603	Date 15/12/2014	Echelle 1 : 1
-----------	--------------------	------------------



Bois-Métal 2012 client.dwg

Montants intermédiaire
gauche: guichet ouvrant
droite : guichet ouvrant

Echelle
1 : 1

Date
15/12/2014

BM/66/